

**AN SERIES**

**DIGITAL PANEL INSTRUMENT  
FOR USE WITH LOAD CELL**



**MODEL AN 2000 C**

**INSTRUCTIONS MANUAL**

Edition: May 26 2003

Code: 30727215

Valid for panel meters #668 and so on

*AN 2000 C  
English*

## INTRODUCTION TO THE AN SERIES

**This manual does not constitute a formal agreement. All information given in this manual is subject to change without notice.**

The AN SERIES brings a new philosophy in digital panel instrumentation which is expressed by multipurpose, modular-concept devices providing a rich array of basic functions and advanced capabilities.

With a fully MODULAR DESIGN, it is possible to implement a wide variety of applications by only adding the adequate options.

Intelligence within it allows the instrument to recognize the options installed and ask for the necessary parameters to properly function within desired margins. The parameters related to non-installed options are removed from the program routines.

The instrument's CALIBRATION is made at the factory eliminating the need for adjustment potentiometers.

Any circuit or option liable to be adjusted incorporates a memory where calibration parameters are stored, making it possible the optional cards be totally interchangeable without need of any subsequent adjust.

Custom CONFIGURATION for specific applications can be made quickly and easily through five front panel keys, following structured choice menus aided by display prompts at each programming step.

Other features of the AN family include:

- CONNECTIONS via plug-in terminal blocks without screws and CLEMP-WAGO clips cable retention system
- DIMENSIONS  
Models AN 2000 96x48x120 mm DIN 43700  
Models AN 1500 & AN 1000 96x48x60 mm DIN 43700
- CASE MATERIAL UL-94 V0-rated polycarbonate.
- PANEL INSTALLATION without screws by means of single part fastening clips
- IMPERMEABILITY of the front panel IP65 (Indoor Use).

---

To guarantee the meter's technical specifications, it is recommended to recalibrate the meter at periodical intervals according to the ISO9000 standards for the particular application operating criteria. Calibration should be performed at the factory or in a qualified laboratory.

**DIGITAL PANEL INSTRUMENT****AN SERIES****MODEL AN 2000 C**

## INDEX

1 . MODEL AN 2000 C OVERVIEW .....	4
1.1. - KEYBOARD AND DISPLAY DESCRIPTION.....	6
2 . GETTING STARTED .....	8
2.1 - POWER / CONNECTORS .....	9
2.2 - INTRODUCTION TO THE PROGRAMMING MODE.....	11
2.3 - INPUT CONFIGURATION.....	13
2.4 - DISPLAY CONFIGURATION .....	15
3 . KEYBOARD AND CONNECTORS CONTROLS	
3.1 - KEYBOARD FUNCTIONS.....	25
3.2 - CONNECTORS FUNCTIONS .....	28
3.3 - TABLE OF PROGRAMMABLE FUNCTIONS.....	29
3.4 - LOGIC INPUTS PROGRAMMING .....	31
3.5 - PROGRAMMING LOCK OUT. ACCESS LEVELS.....	33
4 . OUTPUT OPTIONS.....	34
4.1. - ADDED OUTPUT FUNCTIONS.....	36
5 . TECHNICAL SPECIFICATIONS	
5.1. - TECHNICAL FEATURES.....	38
5.2. - DIMENSIONS AND MOUNTING .....	39

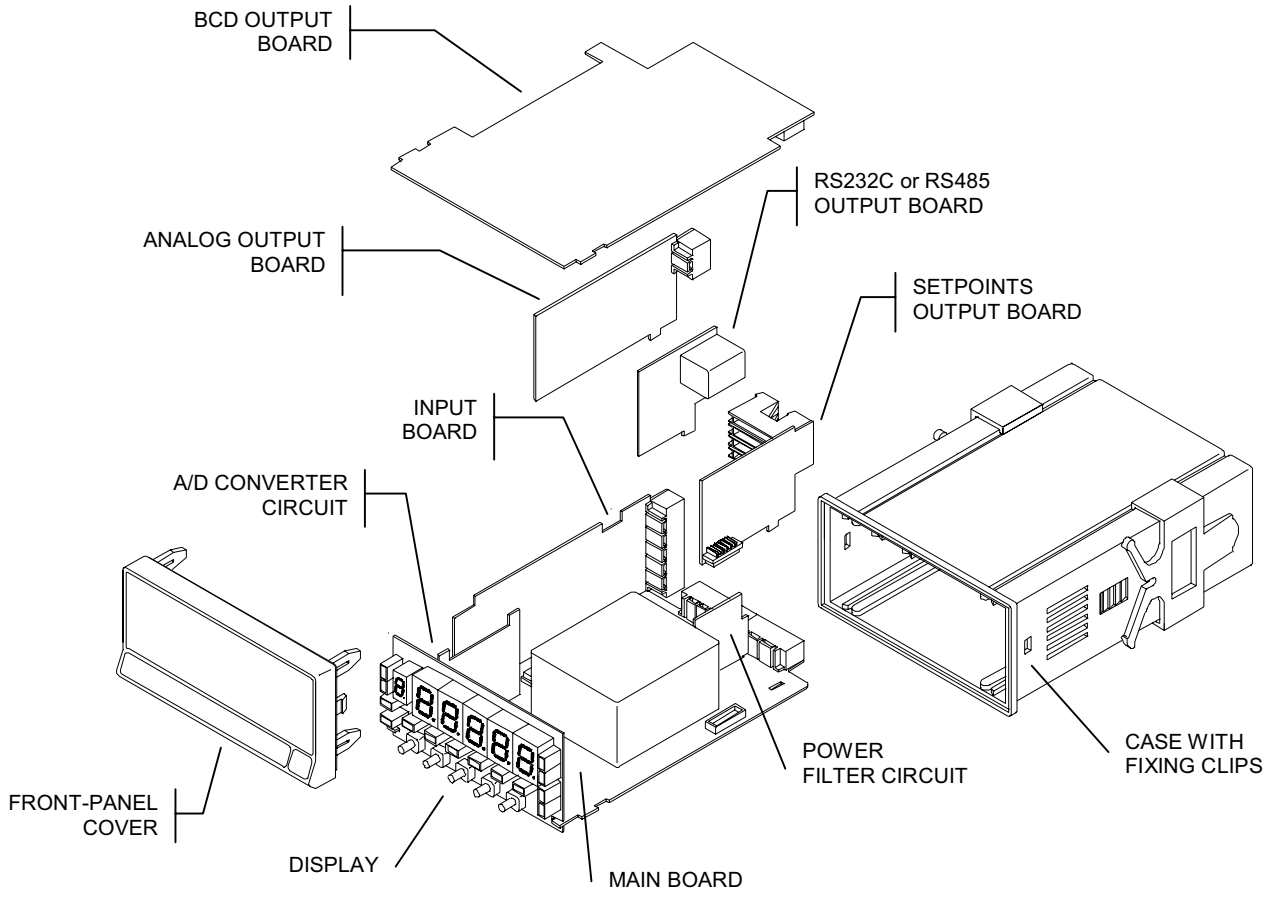

## 1. MODEL AN 2000 C OVERVIEW

**The AN 2000 C model incorporates new technical and functional characteristics including  $\pm 32000$  count display, signal linearization of up to 30 points and user programmable remote logic functions that provides an extraordinary flexibility to adapt to a wide range of indication and control needs.**

The model AN 2000 C of the AN series is a digital indicator designed to measure forces (weight, load, torque, pressure ...) that admits connection of several bridge such as load-cells with small signal levels up to  $\pm 300$  mV.

It provides four selectable input ranges ( $\pm 15$  mV,  $\pm 30$  mV,  $\pm 60$  mV or  $\pm 300$  mV) and two excitation voltages (5 V or 10 V) that allow to accommodate different cell types and input sensitivities. Two programming modes permit scaling the meter to fit the desired units for specific applications.

The meter has two input filtering methods with selectable levels and selectable resolution to help stabilizing the display according to the process type.

The basic instrument is a soldered assembly composed of the MAIN BOARD, the DISPLAY and the power FILTERING circuit, plus the A/D converter card and the INPUT card that are located in their corresponding plug-in connectors (see figure in page 4).

Standard features of the basic instrument include the reading of the input variable, max and min detection, remote hold operation, tare function and reset and a full complement of programmable logic functions.

In addition, a variety of plug-in output cards can be installed at any time to meet further system requirements:

### COMMUNICATION

RS2	Serial RS232C
RS4	Serial RS485
BCD	BCD 24 V/ TTL

### CONTROL

ANA	Analogical 4-20 mA, 0-10 V
2RE	2 SPDT relays 8 A
4RE	4 SPST relays 0.2 A
4OP	4 NPN outputs
4OPP	4 PNP outputs

All the outputs are isolated with respect to the input signal and supply.



This instrument conforms to the following directives: 89/336/CEE and 73/23/CEE  
Caution: Read complete instructions to ensure safety protections.

## FRONT-PANEL FUNCTIONS IN RUN MODE

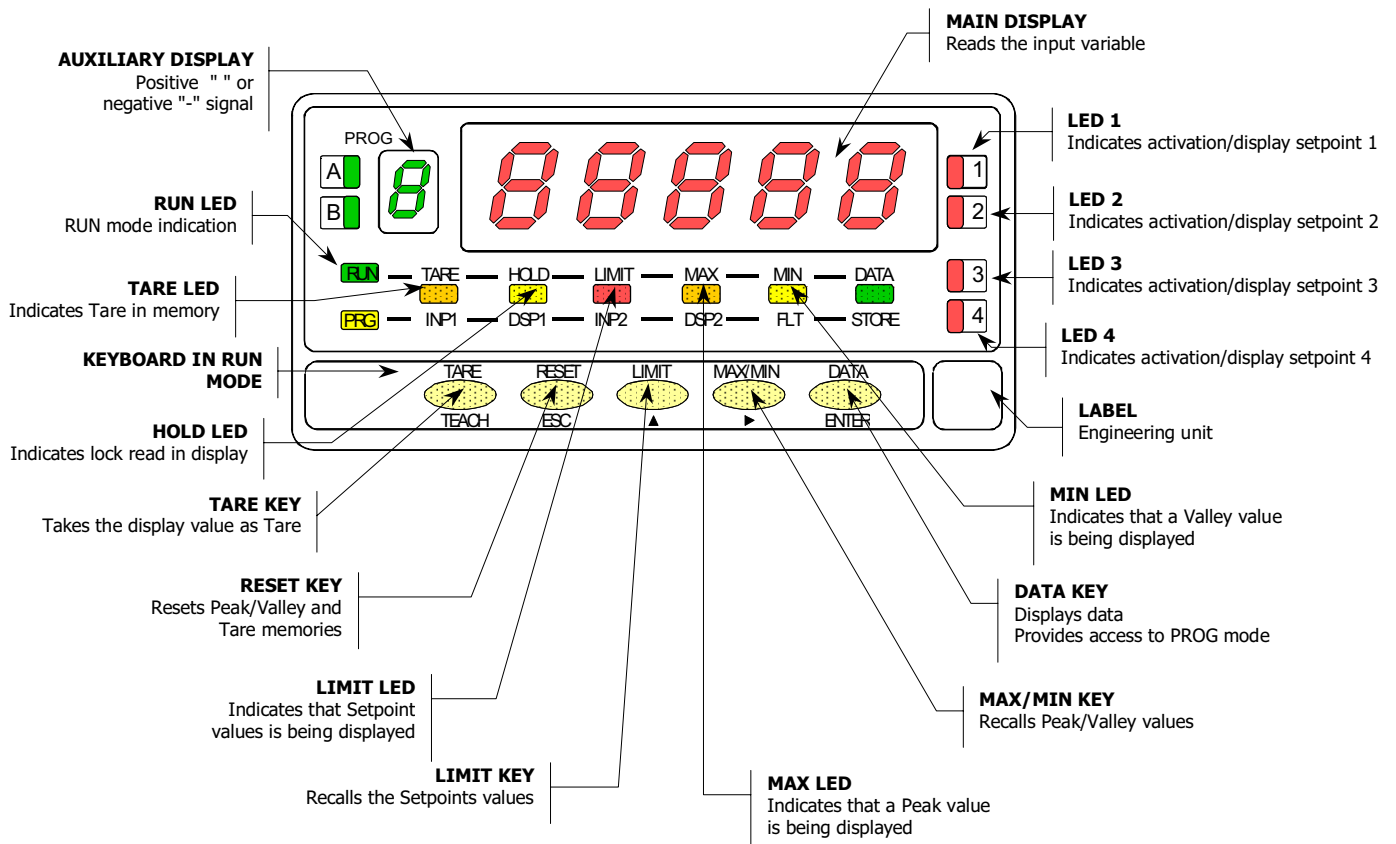

### FRONT-PANEL FUNCTIONS IN PROG MODE

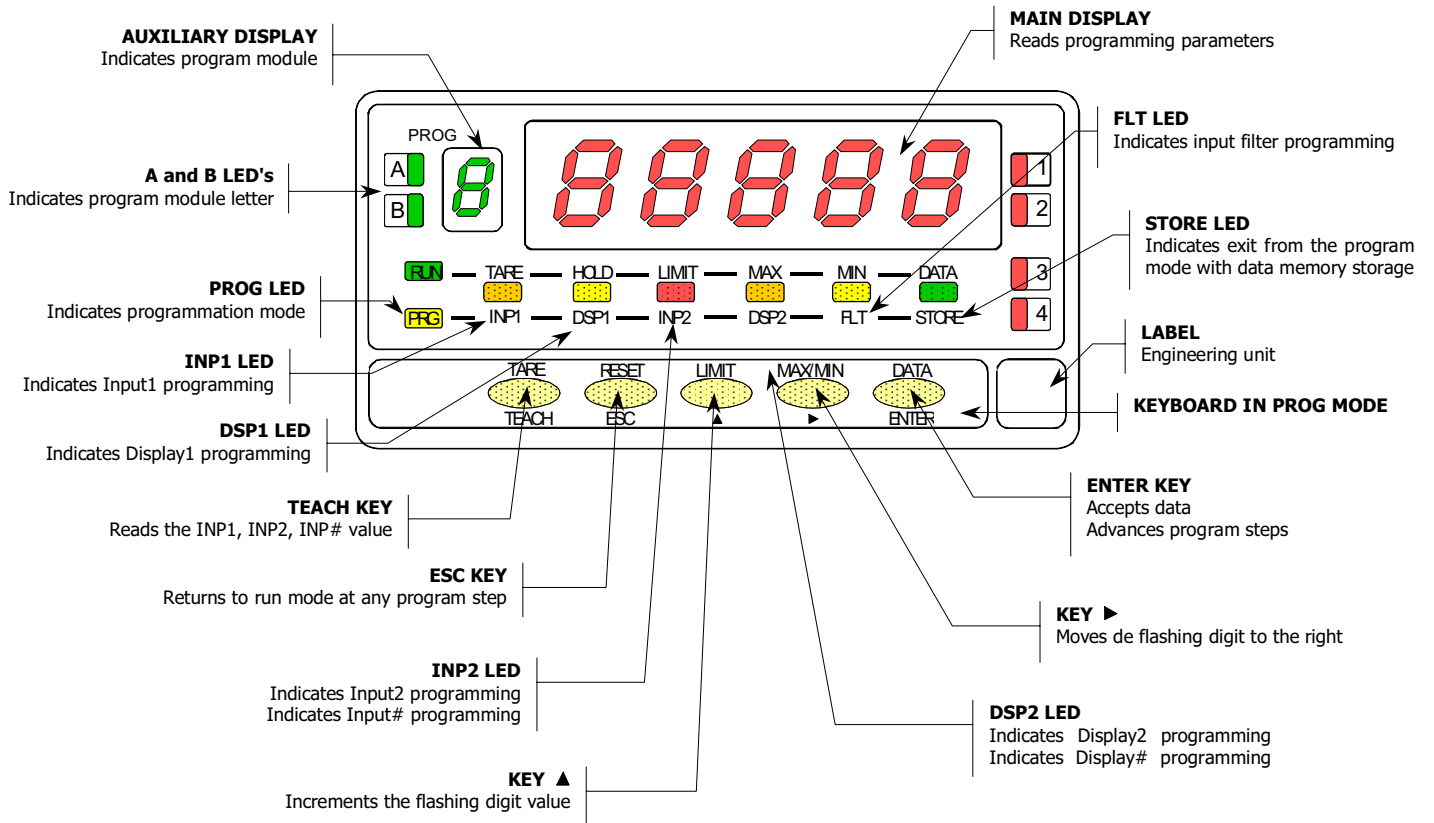

## 2. GETTING STARTED

### PACKAGE CONTENTS

- ❑ Instructions manual in English.
- ❑ D.P.M. model AN 2000 C.
- ❑ Accessories for panel mounting (sealing gasket and fastening clips).
- ❑ Accessories for wiring connections (removable plug-in connectors and fingertip).
- ❑ Wiring label stuck to the AN 2000 C case.
- ❑ Two sets of engineering units labels.

✓ **Check the package contents.**

### CONFIGURATION

Power supply (page 9 and 10)

- ❑ Instruments supplied for 115/ 230 V AC power are factory set for 230 V AC (USA market 115 V AC).
- ❑ Instruments supplied for 24/ 48 V AC power are factory set for 24 V AC.
- ❑ Instruments supplied for 10-30 V DC can be powered from any voltage between 10 and 30 V DC without need of making changes.

✓ **Check the wiring label before power connection.**

Programming instructions (page 11 and 12)

- ❑ The software is divided into several independently accessible modules to configure the input, the display, the setpoints, the analogical output, the output communication and logic inputs.

✓ **Read carefully this section.**

Input type (page 13 and 14)

- ❑ The instrument provides two excitation voltages to supply the transducer (5 V or 10 V). The instrument is set up at fabrication for 10 V.
- ❑ The maximum voltage applicable to the instrument is 300 mV. There are four available input ranges: 15 mV, 30 mV, 60 mV and 300 mV.

✓ **Check the cell sensitivity. If you have any doubt please consult the cell specifications.**

Programming Lock-out (page 33)

- ❑ The instrument is set at the factory with the program routines totally accessible.

**Warning! Keep your unlock code in a secure place.** If you lost it, it is possible to reset it (page 36).



## 2.1 - Power supply

Should any hardware modification be performed, remove the electronics from the case as shown in figure 9.1.

**115/230 V AC:** The instruments with 115/230 V AC power, are shipped from the factory for 230 V AC (USA market 115 V AC), see figure 9.2. To change supply voltage to 115 V AC, set jumpers as indicated in figure 9.3 (see table 1). The wiring label should be modified to match new setups.

**24/48 V AC:** The instruments with 24/48 V AC power supply, are shipped from the factory for 24 V AC, see figure 9.3 To change supply voltage to 48 V AC, set jumpers as indicated in figure 9.2 (see table 1). The wiring label should be modified to match new setups.

**10-30V DC:** The instruments for 10-30V DC power supply are prepared to withstand any voltage between 10 and 30V without need of wiring changes.

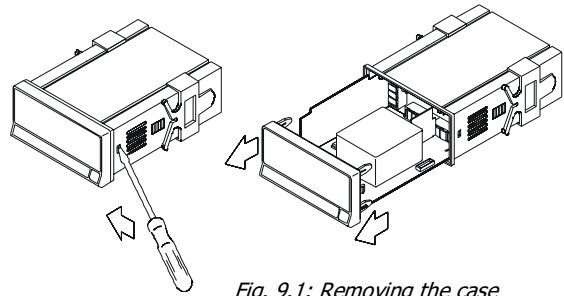

Fig. 9.1: Removing the case

Table 1. Jumper settings

Pin	1	2	3	4	5
230V AC	-	■	■	■	■
115V AC	■	■	■	-	-
48V AC	-	■	■	■	-
24V AC	■	■	■	-	-

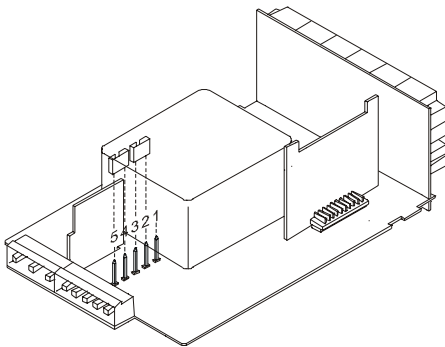

Fig. 9.2. Supply voltage 230 V or 48 V AC

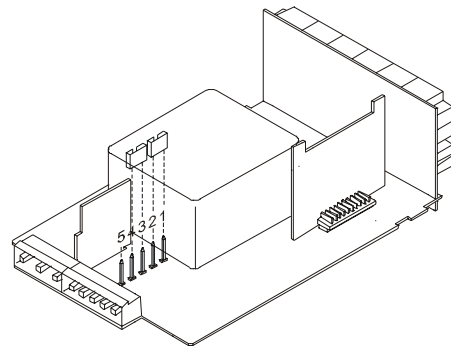
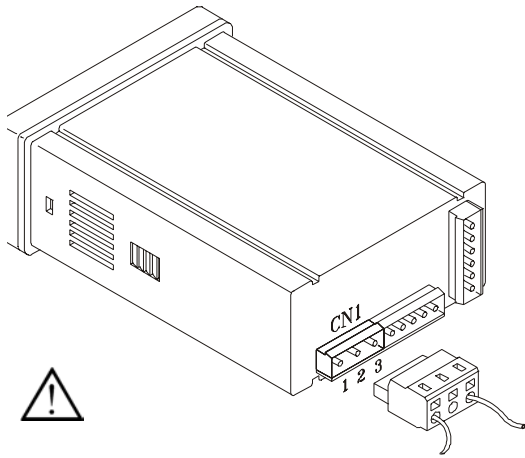

Fig. 9.3. Supply voltage 115 V or 24 V AC

## POWER CONNECTION



### AC VERSIONS

- PIN 1 - AC HI
- PIN 2 - GND (GROUND)
- PIN 3 - AC LO (NEUTRAL)

### DC VERSIONS

- PIN 1 - DC POSITIVE
- PIN 2 - N/C (no connection)
- PIN 3 - DC NEGATIVE

### INSTALLATION

To meet the requirements of the directive EN61010-1, where the unit is permanently connected to the mains supply it is obligatory to install a circuit breaking device easily reachable by the operator and clearly marked as the disconnect device.

### WARNING

In order to guarantee electromagnetic compatibility, the following guidelines for cable wiring must be followed:

- Power supply wires must be routed separated from signal wires. *Never* run power and signal wires in the same conduit.
- Use shielded cable for signal wiring and connect the shield to ground of the indicator (pin2 CN1).
- The cable section must be  $\geq 0.25 \text{ mm}^2$

**If not installed and used according to these instructions, protection against hazards may be impaired.**

### CONNECTORS

To perform wiring connections, remove the terminal block from the meter's connector, strip the wire leaving from 7 to 10 mm exposed and insert it into the proper terminal while pushing the fingertip down to open the clip inside the connector as indicated in the figure.

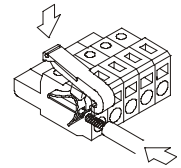

Proceed in the same manner with all pins and plug the terminal block into the corresponding meter's connector.

Each terminal can admit cables of section comprised between  $0.08 \text{ mm}^2$  and  $2.5 \text{ mm}^2$  (AWG 26 ÷ 14).

The blocks provide removable adaptors into each terminal to allow proper fastening for cable sections of  $<0.5 \text{ mm}^2$ .

The blocks provide removable adaptors into each terminal to allow proper fastening for cable sections of  $<0.5 \text{ mm}^2$ .

## 2.2 – Programming instructions

### Access to the programming mode

When power is applied to the instrument, the display briefly illuminates all segments and LED's then shows the software version and finally enters in the normal reading mode. Press **ENTER** to enter in the programming mode. The display shows the indication "-Pro-" (fig. 11.1).

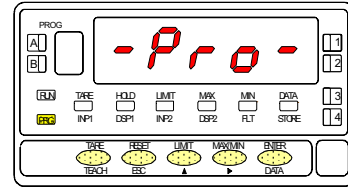

Fig. 11.1. PROG mode first step (-Pro- stage)

### Exit from the programming mode without saving data

From any step of the program routines, a push of **ESC** returns the meter to the run mode. The instrument retains any change made before exiting in this mode but does not save new data in the memory.

### Save changes in the configuration

From the last step of each program menu, a push of **ENTER** returns the meter to the run mode keeping all changes in the parameter list. The LED STORE illuminates while the new configuration is saved in the memory.

### Guidelines on programming instructions

The programming software is divided into 6 modules. Each module is organized in several independently accessible menus and each menu contains a list of parameters necessary to configure a specific function of the meter.

From the -Pro- stage, press repeatedly **▶** to cycle around the existing modules: module 10 = Input configuration, module 20 = display configuration, module 30 (if option installed) = setpoints, module 40 (if option installed) = analogical output, module 50 (if option installed) = serial outputs and module 60 = logic functions. Press **ENTER** to accede selected module.

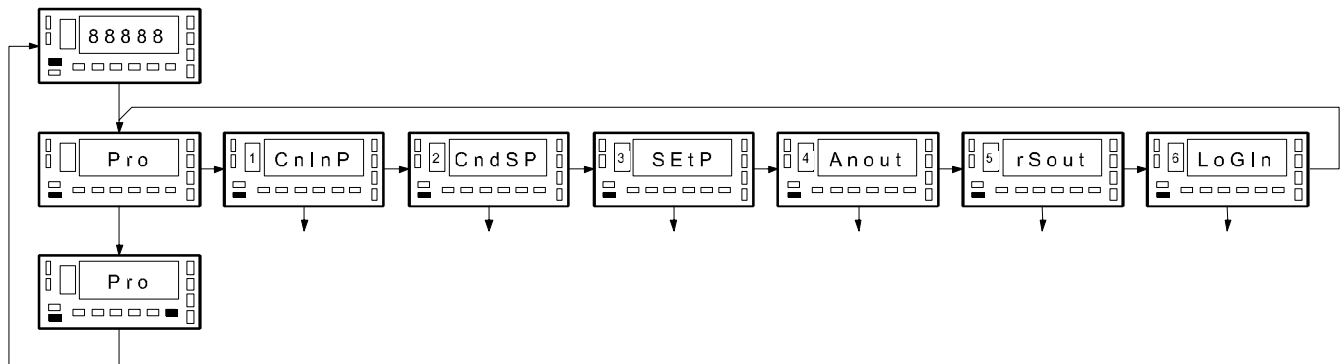

The programming instructions are composed by a general description and a series of step-by-step instructions to be followed sequentially. Each menu step is represented by an illustration of the display and keyboard module with indicators (display and LED's), reference [page number. figure number] and a text describing the action of each key at that step.

**[page n°/figure n°] Mnemo**

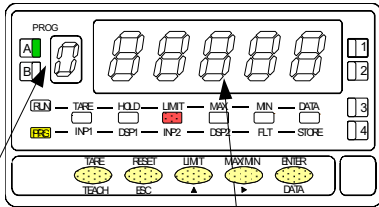

Program module and menu step indicators

In the step-by-step instructions, you are given the action of the three buttons mainly used to program data. The normal procedure at each step is to push on **▶** a number of times to make changes and push on **ENTER** to validate changes and advance to the next programming step. At the end of a complete menu sequence the meter returns to the run mode saving changes in memory.

In general the following actions can be made during the program mode.

- ENTER** validate changes and advance to next step
- ESC** discard changes and go to the run mode
- ▶** select among a list of available options / shift to next digit to the right
- ▲** increment digit value

With respect to the figures in the step-by-step instructions, the display indications may have the following meanings:

- 1./ The display shows one of the available options with filled-out segments. That means that the display shows the choice made previously. The use of **▶** allows to select from available options.
- 2./ A series of black "8" also represents the display indication of a previous choice, with the difference that it cannot be changed in the current step. If it is already the desired parameter, you may exit from the menu by a push of **ESC** without making changes or, if wanted to modify it, a push of **ENTER** advances the meter to the next step where changes are allowed.
- 3./ A series of white "8" represents any numerical value that is programmed by using keys **▲** (increment digit value) and **▶** (advance to the next digit).

### 2.3 - Input configuration

To completely configure the input of the load-cell indicator, it will be necessary to act on these two parameters:

1./ Excitation voltage selection.

The indicator provides two excitation voltages to supply the transducer; 5 V or 10 V. The selection is made by means of a plug-in jumper located behind the input card connector.

Refer to the figure 13.1 to locate the jumper positions.

2./ Input connection

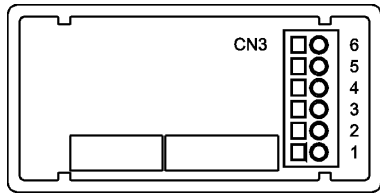

- PIN 6 = -EXC
- PIN 5 = +EXC
- PIN 4 = N/C
- PIN 3 = -mV
- PIN 2 = N/C (no connection)
- PIN 1 = +mV (max. 300mV)

Fig. 13.1: Excitation jumper

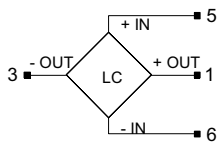
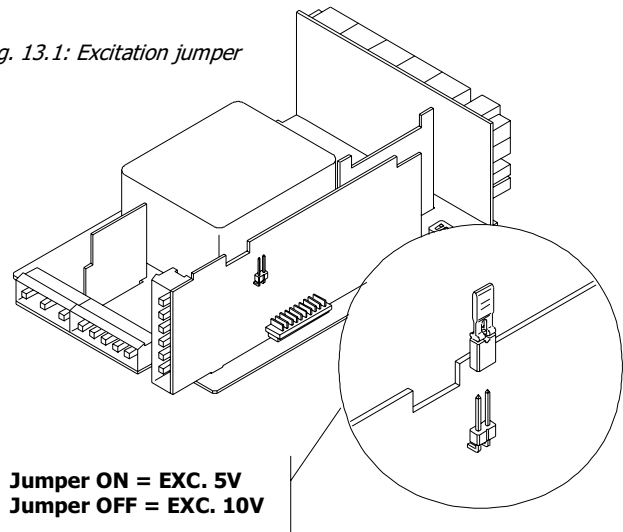

LOAD-CELL

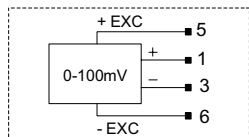

TRANSDUCER 0-100mV

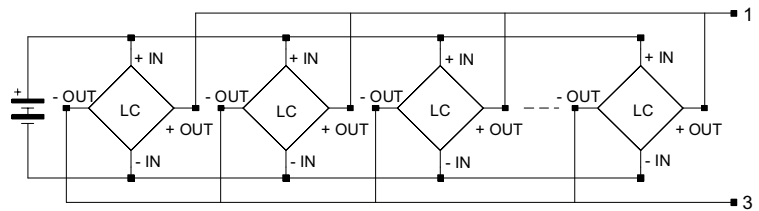

4 OR MORE CELLS CONNECTED IN PARALLEL

### 3./ Input programming range.

The only configurable parameter is the input range. There are four available ranges; 15 mV, 30 mV, 60 mV or 300 mV which are to be chosen to match the cell sensitivity (max. output in mV). The maximum voltage applicable to the instrument is 300 mV. The built-in excitation voltage can be used to power up to 4 cells connected in parallel, with 10 V excitation and up to 8 cells with 5 V excitation. Suppose 4 cells with 2 mV per Volt output that are powered from the 10 V excitation source so each one drives out 20 mV. Since they are connected in parallel, the total output voltage is 20 mV. For this configuration the instrument should be programmed for an input range of 30 mV.

After deciding the input range, we are ready to enter in the input configuration module (1 CnInP) to program this parameter. Connect the instrument to the power supply. For a few seconds, the display will illuminate all segments, decimal points and LED's as a test of their proper operation.

#### [14.1] Input configuration

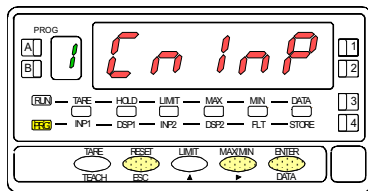

From the run mode, press **ENTER** to get access to the programming mode (the -Pro- indication appears on the display). Press the **▶** key to make the display show the indication given by the figure 14.1. that corresponds to the entry into the input programming module.

- ▶** To skip over this stage and go to the next programming module.
- ENTER** To exit from programming mode and return the meter to the run mode.

#### [14.2] Input range

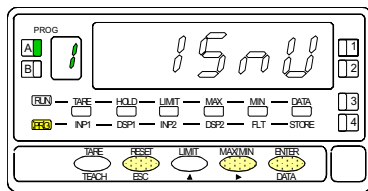

The display shows the previously-selected input range. If it is already the desired one, press **ESC** to return to the run mode. To modify this parameter, press repeatedly the **▶** key until the desired input range ["15mV", "30mV", "60mV" or "300mV"] appears on the display.

- ENTER** To save the entry in the memory and go to the run mode.

### 3.2 - Display configuration

After selection of the input range, it may be necessary to scale the instrument for the particular application. For many common applications, single slope scaling (2 points) should be sufficient to have good readings over the entire process range. Other applications, in which non-linear devices are used may require linearizing the signal. This is accomplished by scaling the meter with more than two points (see fig. 17.1)

Type of function	Nº of scaling points
Linear function	2 points
Non-linear function	Max 30 points

#### 1./ Scaling the display.

The procedure of scaling the display consists of programming a minimum of two points composed each by an input (INP#) and a display (DSP#) coordinates.

When scaling the meter with two points (linear function), they should be located near the process limits for the best possible accuracy.

For multi-point scaling, it is recommended to use the most possible number of points and to reduce the segment length. **The input signal values of the scaling points must be all increasing or all decreasing. Avoid programming two different displays for two equal inputs.** The display values can be entered in any order and even be repeated for two or more input values.

Fig. 15.1: Linearizing function with 6 segments (7 points). Up to 11 segments are available.

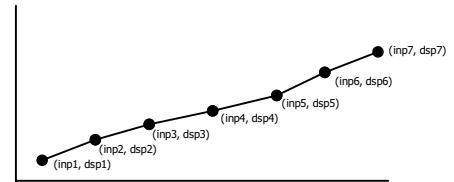

#### 2./ Action modes

The figure below represents two modes of operation obtained by programming increasing or decreasing display values for increasing input values.

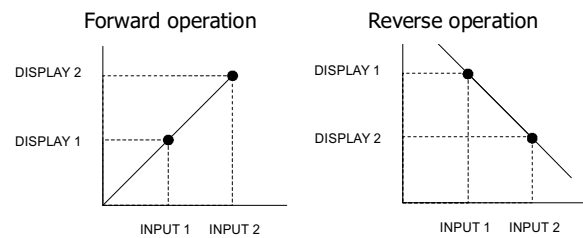

#### Forward operation:

- When input signal *increases*, the display *increases*.
- When input signal *decreases*, the display *decreases*.

#### Reverse operation:

- When input signal *increases*, the display *decreases*.
- When input signal *decreases*, the display *increases*.

3./ Scaling the indicator.

After deciding the values for INPUT and DISPLAY and the decimal point position, we are ready to enter in the display configuration module (2 CndSP) to effectively scale the meter. The scaling procedure is completed with digital filters and display rounding.

**[16.1] Display configuration**

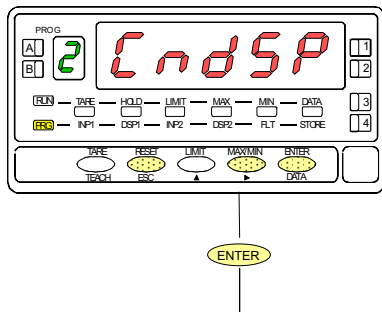

From the run mode, press **ENTER** to get access to the programming mode (the display shows -Pro-). Press two times the **▶** key to go to the entry stage of the display configuration module, represented in fig. 16.1. This module provides four menus: scaling, balanced filter, damping filter and round. Press **ENTER** to access to the first menu (SCAL) and press repeatedly the **▶** key if you want to shift around the different menus (See next pages for instructions on each menu).

**▶** (From 2 CndSP stage) skips over this module and advances to the next one or to the -Pro- stage.

**ESC** Exits from the programming routines and brings the instrument to the run mode.

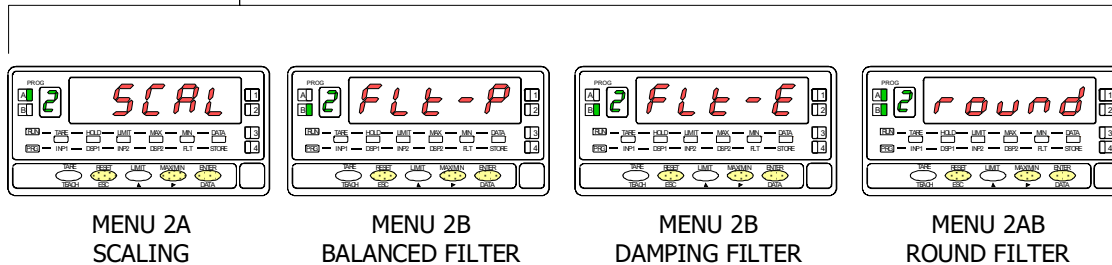



## MENU 2A - SCALING

This menu allows programming the necessary parameters to determine the display range (INP1 - DSP1 - Decimal Point - INP2 - DSP2 - INP3 - DSP3 ...). As a default, these values are expected to be introduced by keyboard. To use the actual signal input values as INP# parameters, it is sufficient to push on the **TEACH** key at INPUT programming phases.

**VERY IMPORTANT: Scaling the meter with a tare value different from zero may cause false readings. Before trying to program the scale, check the TARE LED and, if activated proceed to clear the tare memory (Fig. 25.2).**

### [17.1] Scaling configuration

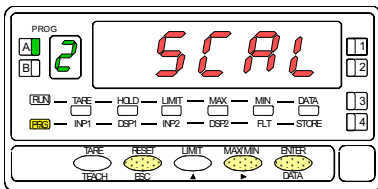

The figure 17.1 shows the indication (**SCAL**) corresponding to entry stage into the scaling menu. Press **ENTER** to accede this menu.

- ENTER** To accede the scale configuration.
- ▶** To skip over this stage and go to the next programming menu.
- ESC** To exit from the programming mode without saving changes.

### [17.2] Input 1 value

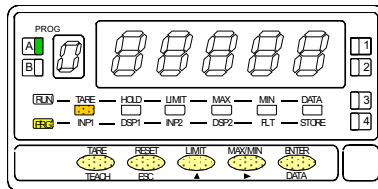

The previously programmed INP1 value appears on the display, LED INP1 activated. There are two methods to program input values :

**Key-in method:** Use **▲** to switch between "0" (positive) and "-" (negative). Press **▶** to advance to the next digit to the right which goes in flash. Press repeatedly **▲** to increment the active digit until it takes desired value. Proceed in the same manner with all the digits until desired value is completed on the display with sign. Press **ENTER** to accept this value as INP1 and go next step.

**Teach method:** Apply signal to the meter input. Press **TEACH** to view the actual signal value present at the input connector, LED INP1 flashes. Press **ENTER** to accept this value as INP1 and go next step.

- ESC** To exit from the programming mode without saving changes.

### [17.3] Display 1 value

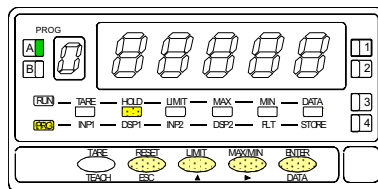

Programming of the display value for the first point, LED DSP1. By means of the **▲** and **▶** procedure, program desired DSP1 value and press **ENTER**. The limits of the span are -32000 and 32000 points. If the programmed value exceeds from these limits, the meter indicates Error, then displays 32000 with the first digit in flash to allow reprogramming the DSP1 value within limits.

- ENTER** To save the entry into the memory and go to the next programming menu.
- ESC** To exit from the programming mode without saving changes.

**[18.1] Decimal point**

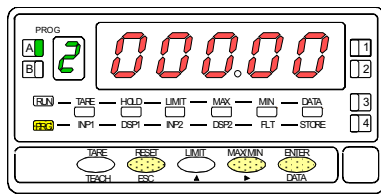

The decimal point goes in flash.

Press repeatedly the **▶** key to move it to the right until desired position. If no decimal point is required, it must be placed to the right side of the display. The decimal point remains in the selected position in all programming phases and the run mode.

**ENTER** To save the entry into the memory and go to the next programming menu

**ESC** To exit from the programming mode without saving changes.

**[18.2] Input 2 value**

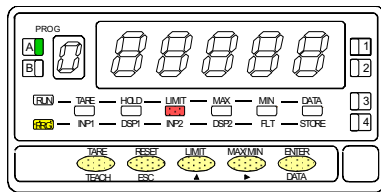

The previously programmed INP2 value appears on the display, LED INP2 activated. There are two methods to program input values :

**Key-in method:** Use **▲** to switch between "0" (positive) and "-" (negative). Press **▶** to advance to the next digit to the right which goes in flash. Press repeatedly **▲** to increment the active digit until it takes desired value. Proceed in the same manner with all the digits until desired value is completed on the display with sign. Press **ENTER** to accept this value as INP2 and go next step.

**Teach method:** Apply signal to the meter input. Press **TEACH** to view the actual signal value present at the input connector, LED INP2 flashes. Press **ENTER** to accept this value as INP2 and go next step.

**ESC** To exit from the programming mode without saving changes.

**[18.3] Display 2 value**

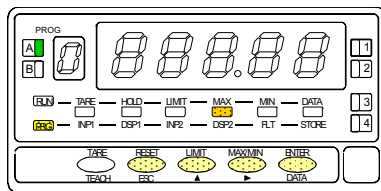

Programming of the display value for the first point, activated LED DSP2. By means of the **▲** and **▶** procedure, program desired DSP2 value and press **ENTER**. The limits of the span are -32000 and 32000 points. If the programmed value exceeds from these limits, the meter indicates Error, then displays 32000 with the first digit in flash to allow reprogramming the DSP2 value within limits.

a) To save the entry into the memory and return to run mode, press **ENTER**;

b) To access to the scale lineization points, press **ENTER** 3 seconds.

**ESC** To exit from the programming mode without saving changes.

**VERY IMPORTANT:** Scaling the meter with a tare value different from zero may cause false readings. Before trying to program the scale, check the TARE LED and, if activated proceed to clear the tare memory (Fig. 25.2).

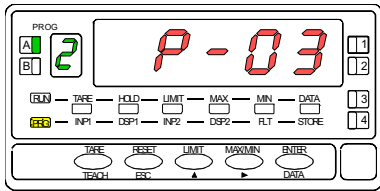
**[19.1] Point 3**

1 second flag indication for scaling point 3.

Multi-slope scaling sequence begins at this step.

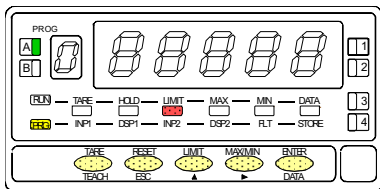
**[19.2] Input 3 value**

The previously programmed INP3 value appears on the display, LED INP2 activated. There are two methods to program input values :

**Key-in method:** Use **▲** to switch between "0" (positive) and "-" (negative). Press **▶** to advance to the next digit to the right which goes in flash. Press repeatedly **▲** to increment the active digit until it takes desired value. Proceed in the same manner with all the digits until desired value is completed on the display with sign. Press **ENTER** to accept this value as INP3 and go next step.

**Teach method:** Apply signal to the meter input. Press **TEACH** to view the actual signal value present at the input connector, LED INP2 flashes. Press **ENTER** to accept this value as INP3 and go next step.

**ESC** To exit from the programming mode without saving changes.

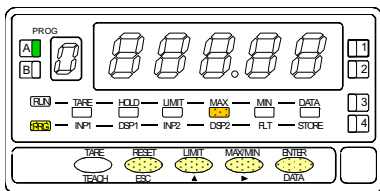
**[19.3] Display 3 value**

Programming of the display value for the third point, activated LED DSP2. By means of the **▲** and **▶** procedure, program desired DSP3 value and press **ENTER**. The limits of the span are -32000 and 32000 points. If the programmed value exceeds from these limits, the meter indicates Error, then displays 32000 with the first digit in flash to allow reprogramming the DSP3 value within limits.

- To validate data and advance to the next point ; press **ENTER** ; or
- To save the programmed data in the memory and return to the run mode (the meter is scaled by three points), press and hold down **ENTER** for 3 seconds.

**ESC** To exit from the programming mode without saving changes.

**[20.2] Point 4**

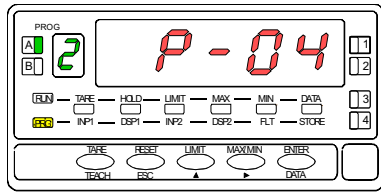

1 second flag indication for scaling point 4.

NOTE: The instructions given for programming point 4 are applicable to the programming of points 5 to 30.

**[20.2] Input 4 value**

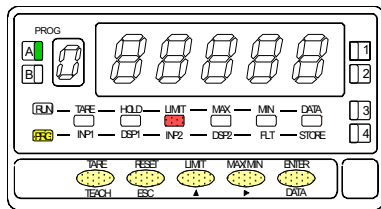

The previously programmed INP4 value appears on the display, LED INP2 activated.

There are two methods to program input values:  
**Key-in method:** Use **▲** to switch between "0" (positive) and "-" (negative). Press **▶** to advance to the next digit to the right which goes in flash. Press repeatedly **▲** to increment the active digit until it takes desired value. Proceed in the same manner with all the digits until desired value is completed on the display with sign. Press **ENTER** to accept this value as INP4 and go next step.

**Teach method:** Apply signal to the meter input. Press **TEACH** to view the actual signal value present at the input connector, LED INP2 flashes. Press **ENTER** to accept this value as INP4 and go next step.

**ESC** To exit from the programming mode without saving changes.

**[20.3] Display 4 value**

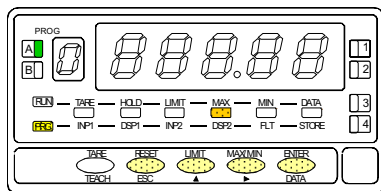

Programming of the display value for the fourth point activated LED DSP2. By means of the **▲** and **▶** procedure, program desired DSP4 value and press **ENTER**. The limits of the span are -32000 and 32000 points. If the programmed value exceeds from these limits, the meter indicates Error, then displays 32000 with the first digit in flash to allow reprogramming the DSP4 value within limits.

- a) To validate data and advance to the next point ; press **ENTER** ; or
- b) To save the programmed data in the memory and return to the run mode (the meter is scaled by four points), press and hold down **ENTER** for 3 seconds.

**ESC** Return to previous point.

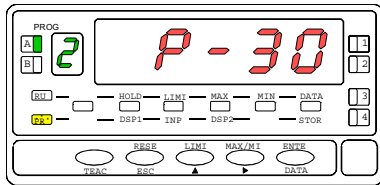
**[21.2] Point 30**

1 second flag indication for scaling point 30.

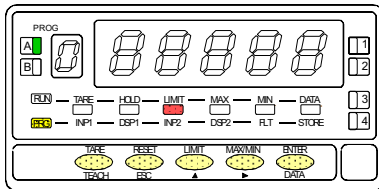
**[21.2] Input 30 value**

The previously programmed INP30 value appears on the display, LED INP2 activated. There are two methods to program input values:

**Key-in method:** Use **▲** to switch between "0" (positive) and "-" (negative). Press **▶** to advance to the next digit to the right, which goes in flash. Press repeatedly **▲** to increment the active digit until it takes desired value. Proceed in the same manner with all the digits until desired value is completed on the display with sign. Press **ENTER** to accept this value as INP30 and go next step.

**Teach method:** Apply signal to the meter input. Press **TEACH** to view the actual signal value present at the input connector, LED INP2 flashes. Press **ENTER** to accept this value as INP30 and go next step.

**ESC** To exit from the programming mode without saving changes.

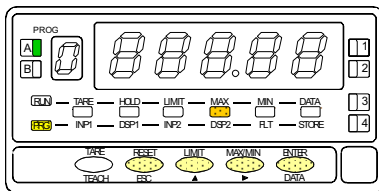
**[21.3] Display 30 value**

Program the display value for the point 30, LED DSP30 activated. By means of the **▲** and **▶** procedure, program desired DSP30 value and press **ENTER**. The limits of the span are -32000 and 32000 points. If the programmed value exceeds from these limits, the meter indicates Error, then displays 32000 with the first digit in flash to allow reprogramming the DSP12 value within limits.

**ENTER** To save the entry into the memory and return to run mode.

**ESC** Return to previous point.

## MENU 2B - BALANCED FILTER

The balanced filter acts as a delay on the display response to signal variations produced at the input. The effect of incrementing this filter level results in a softer response of the display to the input variations.

The filtering level is programmable from 0 to 9. Level 0 disables the filter.

### [22.1] Balanced filter

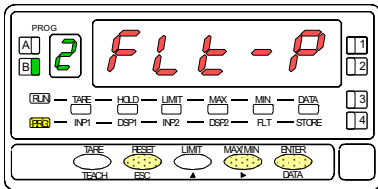

The figure 22.1 shows the indication (**FLt-P**) corresponding to entry stage of the balanced filter menu. Press the **ENTER** key to accede this menu.

- ENTER** To accede to the programming filter.
- ▶** To skip over this menu and go to next one.
- ESC** To exit from the programming mode without saving changes.

### [22.2] Filter value

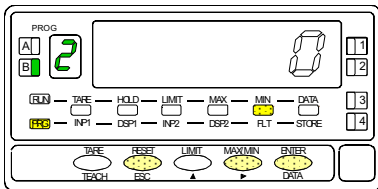

The figure 22.2 shows the initially selected level for the filter-P (any number between 0 and 9) with the FLT LED activated.

Press repeatedly the **▶** key to change the digit until desired value appears on the display.

- ENTER** To save the entry into the memory and go to the next programming menu.
- ESC** To exit from the programming mode without saving changes.

## MENU 2B - DAMPING FILTER

The damping filter cuts off input values exceeding from the limits of a symmetrical band. This band becomes more selective as the filter level is increased.

The filtering level is programmable from 0 to 9. Level 0 disables the filter.

### [23.1] Damping filter

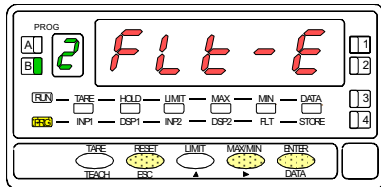

The figure 23.1 shows the indication (**FLt-E**) corresponding to entry stage of the damping filter menu. Press the **ENTER** key to accede this menu.

- ENTER** To access to program the filter level.
- ▶** To skip over this menu and go to next one.
- ESC** To exit from the programming mode without saving changes.

### [23.2] Filter value

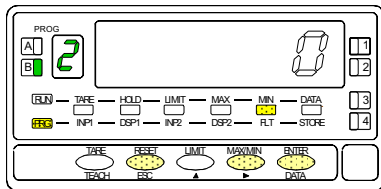

The figure 23.2 shows the initially selected level for the filter-E (any number between 0 and 9) with the FLT LED activated.

Press repeatedly the **▶** key to change the digit until desired value appears on the display.

- ENTER** To save the entry into the memory and go to the next programming menu.
- ESC** To exit from the programming mode without saving changes.

## MENU 2AB - ROUND FILTER

This menu allows selection among 4 levels of display rounding. When resolution is not critical, a rounding increment higher than 1, may help to stabilize the display.

### [24.1] Round filter

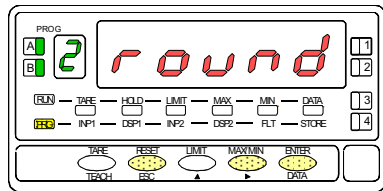

The figure 24.1 shows the indication (**round**) corresponding to the round menu. Press **ENTER** to access the configurations.

- ENTER** To get access to the round level selection.
- ▶** To Skip over this menu and pass to the next one.
- ESC** To exit from the programming mode without saving changes.

### [24.2] Rounding increment

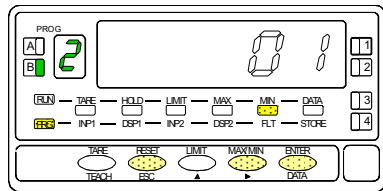

Program the rounding increment, LED FLT activated.

The display shows the previously selected round level. To change this parameter, press repeatedly the **▶** key to rotate around the different options: [**01** = no rounding, **02** = round to 2 counts, **05** = round to 5 counts, **10** = round to 10 counts].

- ENTER** To save the option present on display and return to the run mode.
- ESC** To exit from the programming mode without saving changes.



## 3. KEYBOARD AND REMOTE CONTROLS

### 3.1 - Keyboard functions

The front-panel keyboard includes the following function keys: TARE, RESET, LIMIT and MAX/MIN. The functionality of each one, which is available in the "RUN" mode, is described next.

**TARE.** A push of this key adds the current display value to the tare memory and brings the display to zero. The "TARE" LED indicates that a tare value different from zero is contained in the tare memory.

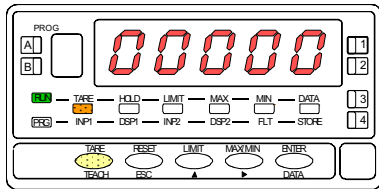

[25.1] Tare operation

**Reset Tare Memory.** Press and hold down the "RESET" key, then press the "TARE" key. Release first "TARE" then "RESET". To take a tare or reset it back to zero, be sure these functions are enabled by software (see Fig. 22.2, TARE menu, UnLoCK option).

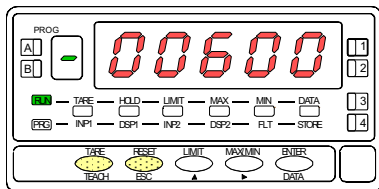

[25.2] Tare reset

**LIMIT.** During the RUN mode, this key is only operative in case that the instrument incorporates one of the following output options: 2 relays (ref. 2RE), 4 relays (ref. 4RE), 4 NPN transistors (ref. 4OP) or 4 PNP transistors (ref. 4OPP). At one push of "LIMIT" key the display illuminates the "limit" LED and reads the first programmed setpoint value with the LED 1 activated. New strokes on the LIMIT key recall successively the rest of the setpoints with the corresponding LED (on the right) activated.

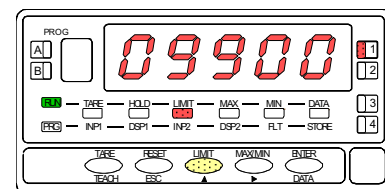

[25.3] Setpoint 1 value

The setpoint values are shown at each push of the "LIMIT" key independently of whether they are enabled or inhibited. 15 seconds after the last key operation or by a push of "LIMIT" from the visualisation of the last setpoint, the auxiliary display blanks and the meter returns to the normal reading.

**MAX/MIN.** This key calls up the peak and valley values contained in memory. The first push recalls the maximum value reached for the variable since the last reset operation (peak) and activates the "MAX" LED.

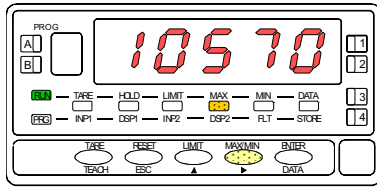

[26.1] Peak

To erase the peak and/or valley memories, press "MAX/MIN" one or two times to display the value to be reset. Press and hold down the "RESET" key and simultaneously press "MAX/MIN". Release "MAX/MIN" then "RESET".

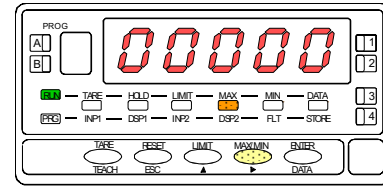

[26.3] Reset of the peak memory

The second push recalls the minimum value registered after the last reset (valley) and activates the "MIN" LED.

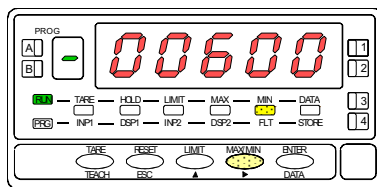

[26.2] Valley

**RESET.** The "RESET" key is used in conjunction with "TARE" and "MAX/MIN" to erase the memories of tare and peak/valley respectively.

When a tare or a tare reset operation is performed, the peak and valley are updated with the new display value.

**BACK TO FACTORY CONFIGURATION**

See page 36.

A third push brings the meter to the normal reading. The peak and valley values are updated even when they are registered on the display.

### 3.2 - Remote functions (CN2)

The rear connector CN2 provides 4 user programmable optocoupled inputs that can be operated from external contacts or logic levels supplied by an electronic system. Four different functions may be then added to the functions available from the front-panel keys. Each function is associated to one of the CN2 connector pins (PIN 1, PIN 2, PIN 4 and PIN 5) and is activated by applying a falling edge or a low level pulse to the corresponding pin with respect to common (PIN 3). Each pin can be assigned one of the 36 functions listed on the following pages.

- **Default configuration**

As shipped from the factory, the CN2 connector allows the TARE, MAX/MIN and RESET operations be made in the same way as from the front-panel keyboard and incorporates one more function: the display HOLD.

The HOLD state, which is acknowledged by the LED "HOLD", freezes the display, the BCD and the analog outputs but does not halt the meter's internal operation nor the alarm outputs. The HOLD state is maintained as long as pin2 is kept to a low level with respect to pin 3.

**CN2 : DEFAULT CONFIGURATION**

PIN (INPUT)	Function	Number
PIN 1 (INP-1)	RESET	Function nº 7
PIN 2 (INP-2)	HOLD	Function nº 9
PIN 3	COMMON	
PIN 4 (INP-4)	TARE	Function nº 1
PIN 5 (INP-5)	PEAK/VALLEY	Function nº 6

*The external electronics applied to the CN2 connector must be capable of withstanding 40 V and 20 mA present at all terminals with respect to COMMON. In order to guarantee the electromagnetic compatibility, please refer to the instructions given on page 10.*

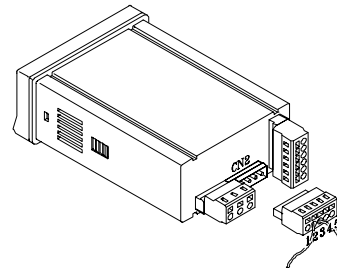
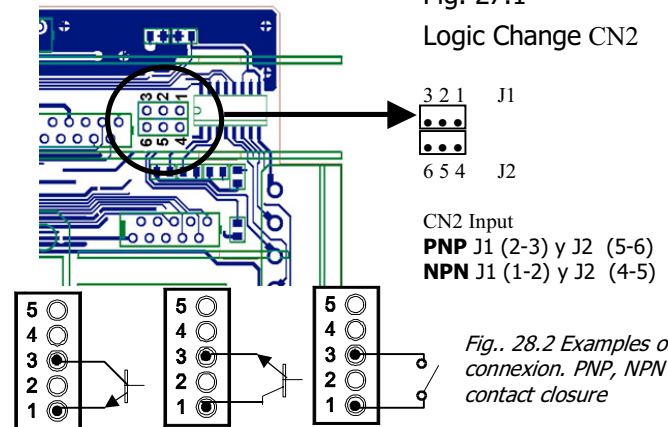

Fig. 27.1  
Logic Change CN2



### 3.3 - Table of programmable functions

- N°: Function number.
- Function: Function name.
- Description: Description and characteristics of the function.
- Activation:
  - Falling edge: The operation is performed on a falling edge applied to the pin with respect to COMMON.
  - Low level: The function remains activated while the corresponding pin is held at a low level with respect to COMMON.
- (\*) Default factory configuration. It can be restored by programming all pins to '0'.

#### 0 to 9: DISPLAY / MEMORY FUNCTIONS

N°	Function	Description	Activation
0	None	Deactivated. The pin has no function	None
1	TARE (*)	Adds the current display value to the tare memory. The display goes to zero	Falling edge
2	RESET TARE	Adds the tare memory contents to the display value and clears the tare memory	Falling edge
3	PEAK	Recalls peak value. A new falling edge returns to normal reading	Falling edge
4	VALLEY	Recalls valley value. A new falling edge returns to normal reading	Falling edge
5	RESET PEAK/VALLEY	Clears the peak or valley memory (if the values are on display)	Falling edge
6	PEAK/VALLEY (*)	1 <sup>st</sup> push recalls peak, 2 <sup>nd</sup> push recalls valley, 3 <sup>rd</sup> push brings the meter to the indication of the variable being measured	Falling edge
7	RESET (*)	Combined with (1) clears the tare memory Combined with (6) clears the peak or valley memories	Falling edge combined with (1) or (6)
8	HOLD1	Holds the display while the outputs remain active	Low level

#### 10 to 12: FUNCTIONS ASSOCIATED WITH THE DISPLAY OF THE INPUT VARIABLE

N°	Function	Description	Activation
10	INPUT	Displays the actual input signal value in mV (flashing)	Low level
11	GROSS	Displays the measured value + the tare value = gross	Low level
12	TARE	Displays the amount of tare contained in the memory	Low level

## 13 to 16 : FUNCTIONS ASSOCIATED WITH THE ANALOG OUTPUT

N°	Function	Description	Activation
13	ANA GROSS	Makes the analog output follow the gross value (measured value + tare)	Low level
14	ZERO ANA	Puts the analog output to the zero state (0 V for 0-10 V, 4 mA for 4-20 mA)	Low level
15	ANA PEAK	Makes the analog output follow the peak value	Low level
16	ANA VALLEY	Makes the analog output follow the valley value	Low level

## 17 to 23 : FUNCTIONS FOR USE WITH A PRINTER VIA THE RS OUTPUTS

N°	Function	Description	Activation
17	PRINT NET	Prints the net value.	Falling edge
18	PRINT GROSS	Prints the gross value.	Falling edge
19	PRINT TARE	Prints the tare value.	Falling edge
20	PRINT SET1	Prints the setpoint1 value and its output status.	Falling edge
21	PRINT SET2	Prints the setpoint2 value and its output status.	Falling edge
22	PRINT SET3	Prints the setpoint3 value and its output status.	Falling edge
23	PRINT SET4	Prints the setpoint4 value and its output status.	Falling edge

## 24 to 25 : FUNCTIONS ASSOCIATED WITH THE SETPOINTS AND RS OUTPUTS

N°	Function	Description	Activation
24	FALSE SETPOINTS	Exclusively for instruments WITHOUT relays/transistors control outputs card. Allows programming and operation of 4 setpoints.	Low level
25	RESET SETPOINTS	Exclusively for instruments with 1 or more setpoints programmed as "latched setpoints" (That is, the setpoints that once energized remain on the ON status although the alarm condition disappears). Deactivates the setpoints output.	Falling edge

## 26 to 28 : SPECIAL FUNCTIONS

N°	Function	Description	Activation
26	ROUND RS	The display value as sent via the RS output, includes no filtering or rounding.	Low level
27	ROUND BCD	Makes the BCD output follow the display value without rounding.	Low level
28	SEND ASCII	Transmission of the last four digits of the display to a remote serial indicator model MICRA-S. By holding the pin to a low level, the display is continuously sent at a rate of 1 message per second.	Low level or Falling edge

## 29 to 36 : NEW FUNCTIONS

N°	Function	Description	Activated by
29	Deactivate Setpoints	Deactivates the activity of the setpoints and leaves the outputs at still	Low level
30	Batch	Adds the present value of the display to the totalizer and increments the batch counter once.	Impulse
31	Visualize Total	The value of the totalizer appears in the display, alternating its high part and low part of four digits each. The auxiliary display shows "H" or "L", depending of which part we are looking to.	Low level
32	Visualize Batch	The display shows the value of the batch counter. The auxiliary display indicates "b".	Low level
33	Reset Total and Batch	Reset the totalizer and batch counter	Impulse
35	Print Total and Batch	Prints the value of the totalizer and batch counter	Impulse
36	Hold and print the Max.	When activated it resets the value of the Max. Then it saves the maximal value while the function is still activated. Finally it prints it when the function is deactivated	Low level

### 3.4 - Programming the logic inputs

After deciding the functions for each connector pin, we are ready to enter in the logic inputs configuration module (6 LoGIn) to effectively programming the logic inputs.

#### [31.1] Logic inputs

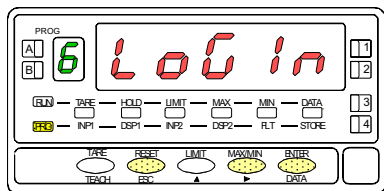

From the run mode, press **ENTER** to get access to the programming mode (the display shows -Pro-). Press six times the **▶** key to go to the entry stage of the logic inputs configuration module, represented in fig. 31.1. This module provides four menus for programming the input pins. Press **ENTER** to accede to the first menu (InP1) and press repeatedly the **▶** key to rotate around the different menus.

- ▶** (From 6 LoGIn stage) skips over this module and advances to the next one or to the -Pro- stage.
- ENTER** Exits from the programming routines and brings the instrument to the run mode.

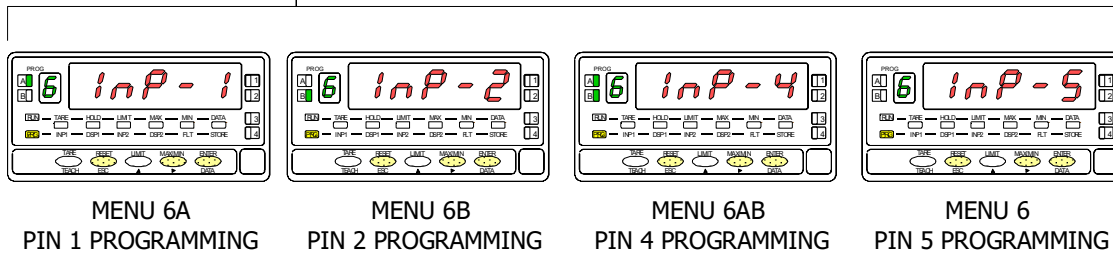

## MENU 6A - PIN 1 programming

This menu allows selecting the logic function for PIN 1. Available functions are represented by a number from 0 to 36. Consult tables to find the number corresponding to the desired function (pages 28 to 30). The instructions given below apply to pin function 1. Follow the same procedure to configure the rest of the pins.

### [32.1] Menu PIN 1

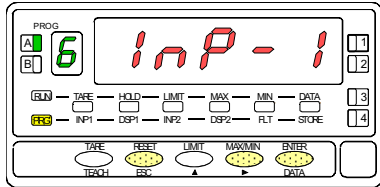

The figure 32.1 shows the indication (**InP-1**) corresponding to the configuration menu for the PIN 1 function. Press the **ENTER** key to accede this configuration.

- ENTER** To access to the programming of the PIN1 function.
- ▶** To skip over this menu and go to PIN 2.
- ESC** To exit from the programming mode without saving changes.

### [32.2] Function number

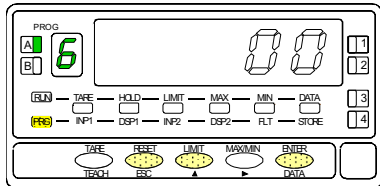

Choose the function number [0-36], according to the table.

- ▲** To change number (hold down to increment automatically).
- ENTER** To save the entry into the memory and return to the run mode.
- ESC** To exit from the programming mode without saving changes.



### 3.5 - Programming lock out / access levels

In the RUN mode pulse the **ENTER** key during 3 second to accede to the lock menu (diagram). The instrument has an original lock code which is "0000". By using the **▲** and **▶** keys, it is possible to enter a new lock **Code**. If the introduced code is false, the instrument goes back in RUN mode. When the display shows "LiSt " pulse **▶** to change the code. **Keep your new code in a secure place!**

It is possible to lock totally or partially the instrument's functions. "1" means lock whereas "0" means unlock. After pressing the last **ENTER**, the instrument saves its new configuration. Pulse **ESC** to return to RUN mode without saving the configuration.

- totLC**..... 1 = Total lock, 0 = can be locked separately each step.
- SEt #** .. Lock prog. Mode Setpoint #.
- InPut** .... Lock prog. Input.
- SCAL** ..... Lock prog. SCAL.
- FiLt**..... Lock prog. Filter.
- AnoUt** ... Lock prog. ANA output
- rSoUt** .... Lock prog. RS output
- LoGIn**.... Lock prog. Logical Functions
- SPVAL** ... Lock prog. Direct access to Setpoints
- tArE**..... Lock keyTARE

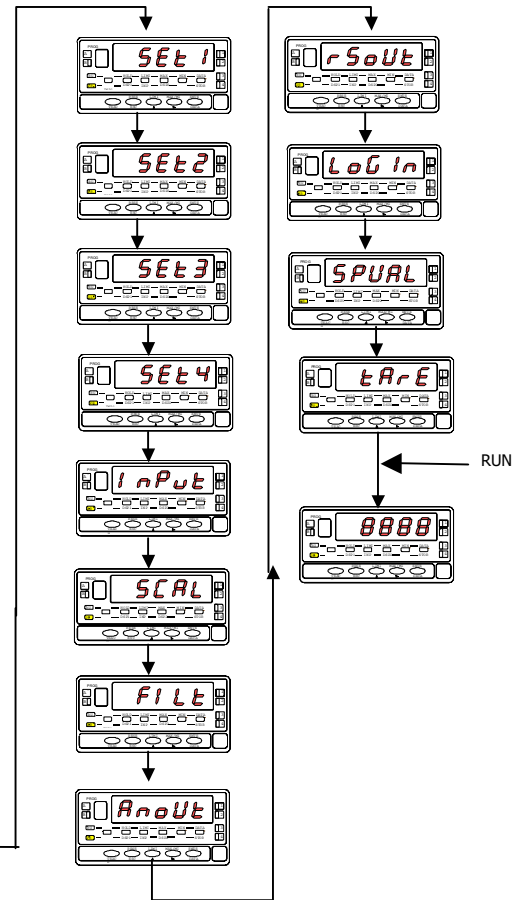
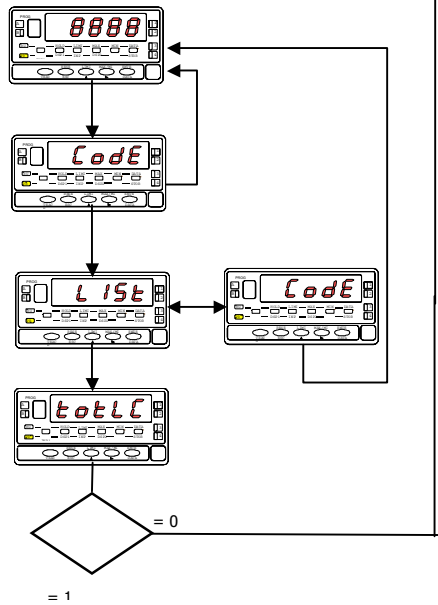

## 4. OUTPUT OPTIONS

Optionally, the model AN 2000 C can incorporate one or several output options for communications (this output should never be connected to the telephone lines) or control including:

### COMMUNICATION

RS2	Serial RS232C
RS4	Serial RS485
BCD	BCD 24V/TTL

### CONTROL

ANA	Analogical 4-20 mA, 0-10 V
2RE	2 SPDT relays 8 A
4RE	4 SPST relays 0.5 A
4OP	4 open-collector NPN outputs
4OP	4 open-collector PNP outputs

All options are optoisolated with respect to the input signal.

The options are supplied with a specific instructions manual describing characteristics, installation, connections and programming. The output cards are easily installed on the meter's main board by means of plug-in connectors and each one activates its own programming module that provides complete software-configuration.

Additional capabilities of the unit with output options :

- Control and processing of limit values via ON/OFF logic outputs (2 relays, 4 relays, 4 NPN outputs or 4 PNP outputs) or proportional output (4-20 mA or 0-10 V).
- Communication, data transmission and remote programming via serial interface.

For more detailed information on characteristics, applications, mounting and programming, please refer to the specific manual supplied with each option.

The figure shows the different locations of the plug-in output cards. Each location corresponds to a specific function: setpoints, analogical and serial outputs.

The options 2RE, 4RE, 4OP and 4OPP are installed in the M5 connector.

The ANA option is installed in the M4 connector.

The options RS2 and RS4 are installed in the M1 connector.

Up to three output options can be present at a time and operate simultaneously, but only one from each category:

- ANALOGICAL
- RS232C or RS485
- 2 RELAYS, 4 RELAYS, 4 PNP or 4 NPN

The BCD output is exclusive and do not allow installation of any other card. This option is connected to the main board by means of a 18-pin FLAT cable.

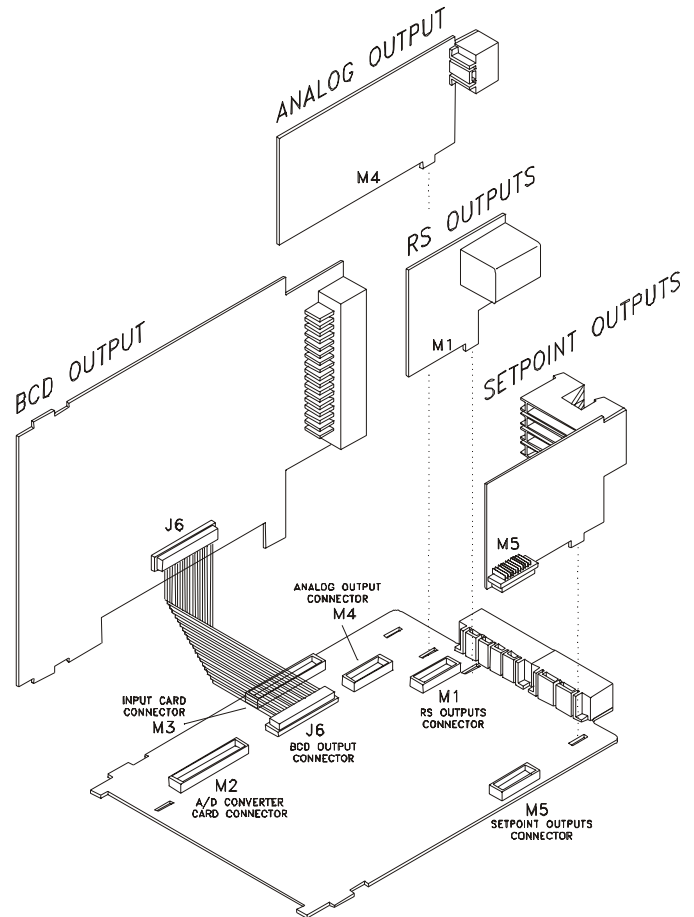

## 4.1 New Functions

The new AN 2000 C provides improved functionality and incorporates new functions from which the following refer to the output options:

### RESET CONFIGURATION

To restore the original configuration, press **ENTER** and **RESET** at the same time during 5 seconds. The lock code will also be put to zero.

### SETPOINTS

1. Each setpoint can be programmed for **auto reset or latched operation**. Latched setpoints require a manual reset to deactivate (see logic function 25, page 29). This may be useful in installations where permanent visual control is not made.
2. Each setpoint can be programmed to **activate** on either the measured net value, gross value, the peak or the valley.
3. Each setpoint may be programmed to **blink** the display when alarm is active. The LED indicator still lights in either case.
4. **Quick access** to program the setpoint values.

5. **Activate or deactivate relay / opto (+LED) via an order from rs232C or rs485.**

This function is available by introducing "3" in the first digit of the parameter mode setpoints (3B ModE).

3	0	0	0	0
---	---	---	---	---

In this configuration the rest of the options (HI-LO, RET-HYS...) are deactivated except the blink option (last digit of the parameter).

Once activated, these options does not deactivate by overflow or by programming, it only wait an order via RS2 or RS4.

6. **Use setpoint2 to detect a peak.**

This function is activated by introducing "6" or "7" in the fourth digit of the parameter mode setpoints (3B ModE).

1	0	0	6	0
---	---	---	---	---

"6" is for the detection of a peak without a filter, and "7" is for the detection of a peak filtered. In this configuration all the other options are activated (Latch, HI-LO, RET-HYS, Blink).

The value parameter of the setpoint (3A SETP) will be the value from which the peak starts to be evaluated.

The value parameter of the delay / hysteresis parameter (3AB ModE) indicates how long will the relay / opt be activated when the peak is reached. (Except in latch mode).

The relay / opto output will be activated when the display stops increasing (once reached the value of setpoint2) during a number of evaluations programmable by the user and between 0 and 99.

The selection of the number of evaluations appears at the continuation of the configuration of setpoint2 after introducing "6" or "7" in the fourth digit.

### RS232

Compatible with ModBus-RTU protocol (see ModBus manual).

### RS485

This output can be used to print several data on a panel printer (see logic functions page 29).

Once chosen the print function, the next step presents on / off to activate the function TIME which prints the time and date.

Compatible with ModBus-RTU protocol (see ModBus manual).

### OUTPUT SERIE

The function 10 (write) is now available in the ModBus protocol, whereas the 01 and 0F are no longer available.

New functions:

Command	Function
---------	----------

Data Request	
Z	Totalizer value
B	Batch Counter value

Orders	
z	Reset Totalizer
x	Reset Batch Counter
a#	Activate setpoint n <sup>o</sup> #
d#	Deactivate setpoint n <sup>o</sup> #

Parameter Modification	
S#	Change the value of setpoint n <sup>o</sup> # without saving it

### ANALOGICAL

See remote inputs, page 29.

### BCD

See remote inputs, page 28 and 29.

## 5. TECHNICAL SPECIFICATIONS

### INPUT SIGNAL

- Configuration ..... differential asymmetrical
- Max Applicable voltage .....  $\pm 300$  mV DC
- Resolution .....  $0.5 \mu\text{V}$
- Input impedance .....  $100 \text{ M}\Omega$
- Excitation .....  $10 \text{ V @ } 120 \text{ mA}$ ,  $5 \text{ V @ } 120 \text{ mA}$

### ACCURACY AT $23^\circ \pm 5^\circ \text{ C}$

- Max. error .....  $\pm (0.1\% \text{ of the reading} + 2 \text{ digits})$
- Temperature coefficient .....  $100 \text{ ppm/ } ^\circ\text{C}$
- Warm-up ..... 10 minutes

### FUSES (DIN 41661) - (recommended)

- AN 2000 C (230/115 V AC) ..... F 0.2 A/ 250 V
- AN 2000 C1 (10-30 V DC) ..... F 2 A/ 250 V
- AN 2000 C2 (24/48 V AC) ..... F 0.5 A/ 250 V

### A/D CONVERSION

- Technique ..... dual slope
- Resolution ..... ( $\pm 16$  bit)
- Read rate ..... 16/ s

### FILTERS

#### Filter P

- Cut -off frequency ( $-3 \text{ dB}$ ) ..... from  $4 \text{ Hz}$  to  $0.05 \text{ Hz}$
- Slope ..... from  $14$  to  $37 \text{ dB/10}$

#### Filter E

- Programmable ..... 10 levels

### DISPLAY

- Main ..... -32000/32000, 5 digits 14 mm red
- Auxiliary ..... 1 digit 7.62 mm green
- Decimal point ..... programmable
- LED's ..... 14 (programming and control)
- Display update time ..... 62 ms
- Positive over-range ..... +oVFLo
- Negative over-range ..... -oVFLo

### POWER SUPPLY

- AC voltages. 115/ 230 V, 24/ 48 V ( $\pm 10\%$ ) 50/60 Hz AC
- DC voltages ..... 10-30 V DC
- Consumption ..... 5 W (without options), 10 W (max.)

### ENVIRONMENTAL

- Operating temp. ....  $-10^\circ\text{C}$  to  $60^\circ\text{C}$  ( $0^\circ\text{C}$  to  $+50^\circ\text{C}$  s/ UL)
- Storage temp. ....  $-25^\circ\text{C}$  to  $+85^\circ\text{C}$
- Relative humidity .....  $< 95 \%$  at  $40^\circ\text{C}$
- Altitude max. .... 2000 m
- Front Sealed ..... IP65 (Indoor use)

### MECHANICAL

- Dimensions .....  $96 \times 48 \times 120 \text{ mm}$
- Panel cut-out .....  $92 \times 45 \text{ mm}$
- Weight ..... 600 g
- Case material ..... UL 94 V-0 rated polycarbonate

## 5.1 - Dimensions and mounting

To install the instrument into the panel, make a 92x45 mm cut-out and insert the instrument into the panel from the front, placing the sealing gasket between this and the front bezel.

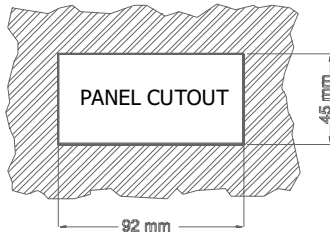

Place the fixing clips on both sides of the case and slide them over the guide tracks until they touch the panel at the rear side.

Press slightly to fasten the bezel to the panel and secure the clips.

To take the instrument out of the panel, pull outwards the rear tabs of the fixing clips to disengage and slide them back over the case.

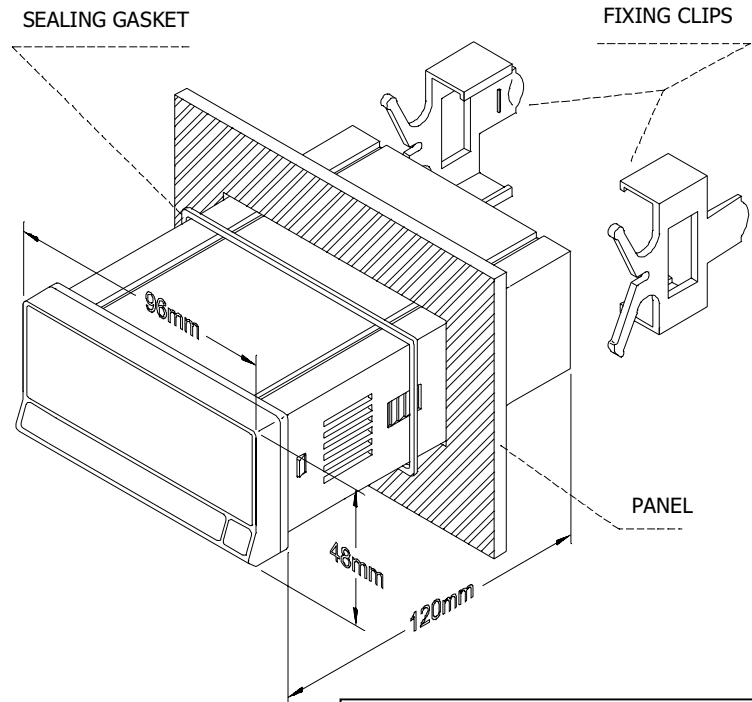

**CLEANING:** The frontal cover should be cleaned only with a soft cloth soaked in neutral soap product.  
DO NOT USE SOLVENTS



*Testing, Measurement and Control of Torque-Speed-Power • Load-Force-Weight • Tension • Displacement*

**www.magtrol.com**

**MAGTROL INC**

70 Gardenville Parkway  
Buffalo, New York 14224 USA  
Phone: +1 716 668 5555  
Fax: +1 716 668 8705  
E-mail: [magtrol@magtrol.com](mailto:magtrol@magtrol.com)

**MAGTROL SA**

Route de Moncor 4B  
1701 Fribourg, Switzerland  
Phone: +41 (0)26 407 3000  
Fax: +41 (0)26 407 3001  
E-mail: [magtrol@magtrol.ch](mailto:magtrol@magtrol.ch)

**Subsidiaries in:**

- Germany
- France
- Great Britain

Worldwide Network  
of Sales Agents

Magtrol SA ISO 9001:2000 certified

