

INSTRUCTION MANUAL

LARGE DIGITAL DISPLAY PROCESS INPUT GAC 057-280

MAGAC057-280/E



MAGTROL

NOTES

CONTENTS.

SECTION	PAGE
INTRODUCTION	4
1.0 UNPACKING AND INSPECTION	5
2.0 GENERAL INFORMATION	5
2.1 Datasheet.....	6,7
3.0 INTERNAL CABLES	8
3.1 Signal cables.....	8
3.2 Power cables.....	8
DETAILED OPERATING INFORMATION	
4.0 Analogue I/P Selection.....	9
4.1 Jumper Functions and Positions.....	9
4.2 Analogue Input connections.....	10
4.3 RS485 output notes.....	10
4.4 Contact Closure Remote Programmer connections.....	11
4.5 Programming your display.....	11
4.6 The Programming Menu	12
4.7 Programming Flow Chart.....	13
4.8 The Configuration Number and what it does.....	14
4.9 1st Config. Number Digit ... Behavior.....	14
4.10 2nd & 3rd Config. Number Digit ... Filtering.....	14
4.11 4th Config. Number Digit ... Data O/P Baud Rate.....	14
4.12 5th Config. Number Digit ... Response Number.....	15
4.13 6th 'INVISIBLE' Config. Number Digit ... Brightness setting.....	15
5.0 INSTALLATION	15
5.1 Mounting positions.....	16
5.2 Panel mounting.....	16
5.3 Wall mounting.....	16
5.4 Suspension mounting.....	16
5.5 Multiple display mounting.....	17
6.0 TROUBLE SHOOTING AND MAINTENANCE, Error messages	17
7.0 SAFETY CONSIDERATIONS .. 	17
8.0 WARRANTY	18
9.0 DIMENSIONS	19

THE PROCESS INPUT MODEL - GAC 057-280

INTRODUCTION

This model is intended for large measurement display use. It accepts the most commonly encountered process signals of 0-10mA, 0-20mA, 4-20ma, 1-5VDC and 0-10VDC, and is fully scaleable to read in engineering units. Scaling can be carried out remotely, whilst the display is in-situ, and because no potentiometers are used, the display stability is superb.

An excitation supply is available to power 2 wire transmitters, or to boost loop drive if required. The decimal point can be placed as required, and the least significant digit can be made to count in units, 2's, 5's or 10's.

The right hand digit can be blanked, effectively 'centralising' the display if less than 5 digit resolution is required.

If specifically ordered, we can supply the displays with a silk screened legend identifying the measurement being displayed, for example, Kg., Deg. C. etc..

An RS485 output is provided, useful for feeding remote mimic displays.

The configuration settings and calibration constants of the display are stored in non-volatile E²PROM memory, which is retained for at least 10 years. Change to the settings is achieved by way of remote contact closure inputs, allowing alteration of the unit's configuration menu, calibration and brightness.

The case is sealed to IP65/NEMA4, and the lens is 4mm thick polycarbonate, making it ideal for use in food industry washdown applications.

1.0 UNPACKING AND INSPECTION

PLEASE check the carton's contents as soon as possible after receipt, to detect any transit damage or losses. Unpack the contents and check each item in the box against the check list below to make sure you have all items.

Check List :

- Handbook
- Display
- Mounting kit (where appropriate)
- Programming Unit (If Ordered)

In the event of damage, please contact the carrier and advise our sales office of the fault.

Please retain the carton packing material, for future possible use.

2.0 GENERAL INFORMATION

This display is part of a family of units for broadcasting process values and data on easy to read large 7 segment displays. Character heights of 57 - 102 - 144 - 200 - 280 mm are standard, and displays have 5 digits. Extra-large and Daylight viewing displays are available to special order.

The enclosures for the displays are of welded UPVC material with tough lenses, providing certified protection to NEMA4 for the internal electronics.

Case colors are white or black.

The units incorporate a 95 to 265VAC power supply (Which can be used on DC in the range 100 to 300 VDC) for operation off any power source without the need to re-configure.

Display brightness is settable to 4 levels to accommodate differing ambient light conditions and the 3 standard character heights provide a choice of viewing distances of up to 20, 40 and 60 metres. Other character heights and brightnesses are available to special order.

The large displays are based around a common power and control card which is linked to display units of different sizes.

Instrument behaviour is set by way of remote contact closure pushbuttons, which provide access to and alteration of the instrument's menu, and the settings are stored in 10 year non-volatile memory.

3.0 INTERNAL CABLES

GAC 057 - 280 Series Large Digital Displays

FEATURES

- Suspension-Mounted Large LED Displays
- Digit Sizes: 57, 102, 144, 203 and 288 mm
- Sealed IP65 for Models 057,102,144: IP54 for models 203 and 280
- Fully Corrosion Resistant
- Adjustable Brightness
- Power Supply: 95 to 265 VAC, optional 11 to 30 VDC or 48 VAC
- Input: 0to 10V, 0-20mA or 4 to 20mA
- Fully Scalable in kg, tonne(t), kN and Other Engineering Units
- Auto Tare Facility
- Optional RS422 Serial Output



DESCRIPTION

For use with Magtrol Load monitoring Units (LMUs) and Load Conditioners (AN Series), these high quality, large character digital displays are used for crane weight display, process weight display and all remote weighing applications. They use microprocessor based technology for high reliability and have nonvolatile memory for all calibration data.

LOAD-FORCE-WEIGHT SYSTEMS

Magtrol Large Digital Displays are used with our Load Monitoring Units (LMUs) or Signal Conditioners (AN Series) as part of a complete measurement system. Magtrol Load Measuring Pins, which measure load and force and provide overload protection, are offered along with a wide range of Load-Force-Weight Transducers in various executions and accuracy classes. Combined, these products constitute an ideal safe measurement system which continuously checks for overloads and short circuits.

SYSTEM CONFIGURATION

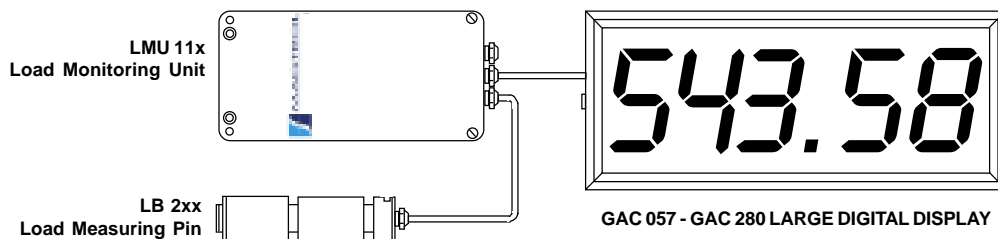

DIMENSIONS

MODEL	Digit Height		Viewing Distance		Unit Width		Unit Height		Unit Depth*		Weight	
	mm	in	m	ft	mm	in	mm	in	mm	in	kg	lb
GAC 057	57	2.2	20	65	288	11.3	120	4.7	90	3.54	2.5	5.5
GAC 102	102	4.0	40	131	480	18.9	168	6.6	90	3.54	4.5	9.9
GAC 144	144	5.7	60	196	624	24.6	192	7.6	90	3.54	5.5	12.1
GAC 200	203	8.0	80	262	824	32.4	248	9.8	90	3.54	7.0	15.4
GAC 280	280	11.0	110	360	1172	43.1	336	13.2	90	3.54	12.0	26.4

* Unit depth does not include stuffing gland, which is approximately 20 mm (0.79 inches) in length.



RATINGS

SIGNAL PROCESSING	
Voltage Input:	
Input Range	0-10 V, 1-5 V
Input Impedance	1.1 MΩ
Current Input:	
Input Range	0-10 mA, 0-20 mA, 4-20 mA
Input Impedance	25 Ω
MEASUREMENT DISPLAY	
Type	7 segments
Display Definition	0 to 99999
Digits / Color	5 digits / red
Scaling	Digital zero and span, by remote contact closure menu
Decimal Point	Position by remote contact closure menu
Count by Facility	Forces last digit to count in steps of 1, 2, 5 or 10
ACCURACY	
Resolution	1 part in 20,000
Maximum Error	0.02% of range, +/- 1 count
Stability	+/- 50 ppm / °C span and offset
Read Rate	2.5 readings per second
Response Time	0.5 seconds
POWER SUPPLY	
AC	95 to 265 VAC, optional 48 VAC
DC (Option)	11 to 30 VDC
ENVIRONMENTAL AND MECHANICAL CHARACTERISTICS	
Operating Temperature	-10 °C to +50 °C
Storage Temperature	-40 °C to +60 °C
Protection Class	IP 65(models 057, 102, 144); IP 54(models 200, 280)

ORDERING INFORMATION

Model Number:

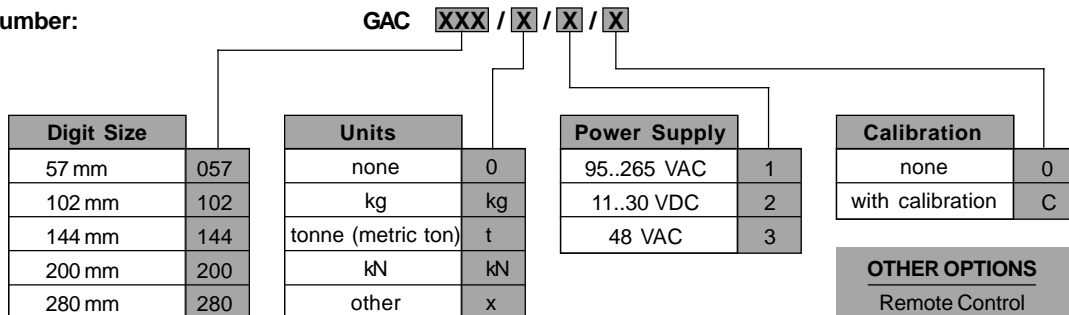

Due to the continual development of our products, we reserve the right to modify specifications without forewarning.



www.magtrol.com

MAGTROL INC

70 Gardenville Parkway
 Buffalo, New York 14224 USA
 Phone: +1 716 668 5555
 Fax: +1 716 668 8705
 E-mail: magtrol@magtrol.com

MAGTROL SA

Route de Moncor 4B
 1701 Fribourg, Switzerland
 Phone: +41 (0)26 407 3000
 Fax: +41 (0)26 407 3001
 E-mail magtrol@magtrol.ch

Subsidiaries in:

Germany
 France
 Great Britain

Worldwide Network
 of Sales Agents



The units are supplied with approximately 2 metres of free ended cable for power, signal and serial ports. You may connect your own cable to this, via a junction box, or completely remove the supplied cable and install your own.

REMEMBER The signals you will be feeding to the displays are quite small in comparison to some of the undesirable ‘noise’ generated by certain types of common electrical equipment. To obtain the highest degree of accuracy and reliability from your indication equipment, we strongly suggest that you....

DO NOT run signal cables adjacent to power/switching lines or near equipment liable to generate large amounts of electrical noise, such as contactors, solenoids, fluorescent tubes, discharge lamps, motor control equipment, etc.

Do use shielded, twisted-pair extension cable to minimise the amount of noise being fed into the display.

WARNING: RISK OF LETHAL ELECTRICAL SHOCK

YOU MAY NEED TO OPEN THE CASE TO ALTER JUMPER POSITIONS OR TO PANEL MOUNT THE DISPLAY. BEFORE COMMENCING TO OPEN THE CASE YOU ~~MUST~~ **MUST ENSURE** THAT POWER HAS BEEN **DISCONNECTED**, AND MUST ENSURE THAT POWER CAN IN NO CIRCUMSTANCES BE RE-APPLIED TO THE DEVICE WHILST THE CASE IS OPEN.

3.1 SIGNAL CABLES

The signal and data connectors are at the left hand end of the power and control card. They are connected to extension cables, which are accessible from the rear of the display.

Do not earth the screen or braid of the input, data output or programmer cable outside the display, as it is already internally earthed to the 'screen' terminal.

○ ○ ○ ○ ○	Analogue Input	1=Screen	Braid
1 2 3 4 5		2=Common	Blue
		3=mA Input	Red
		4=V Input	Green
		5=+Excitation	Yellow

○ ○ ○ ○ ○	Remote Programmer	1=Screen	Braid
1 2 3 4 5		2=Common	Red
		3=Select	Green
		4=Increment	Blue
		5=Menu	Yellow

○ ○ ○ ○ ○	Serial Data O/P	1=Screen	Braid
1 2 3 4		2=Common	Yellow
		3=Data B	Green
		4=Data A	Blue

3.2 POWER CABLES

The unit incorporates a switching power supply to enable the unit to operate over the full Volts range.

265

The **power lead** must be of 3 core construction, with the grounding wire **bonded to a good ground**

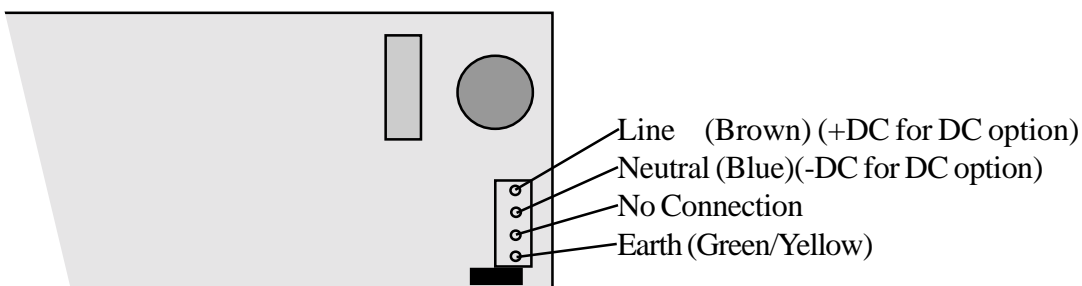

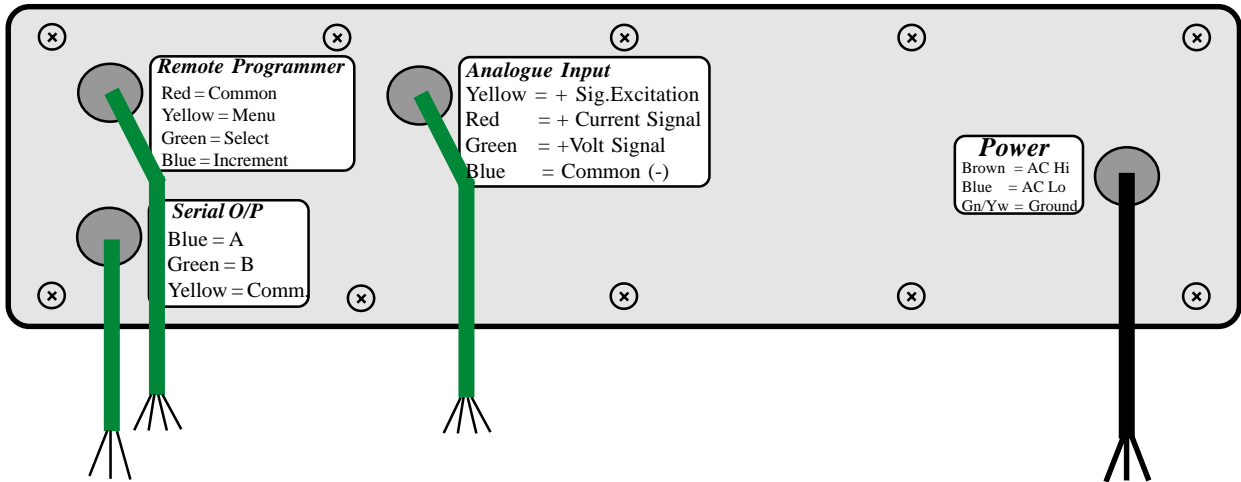

4.0 ANALOGUE INPUT SELECTION

If, when ordering your display you specified the input type required, this will have been set for you prior to despatch, and should be noted on the label on the rear of the display. If you **did not specify** the input type, this will be the **factory default of 4-20mA, reading 0-100.00**. You can re-calibrate the meter, without making any mechanical alterations, to accept 0-20mA, 0-10mA, 0-10V, 1-5V etc.

Simply re-calibrate the display, whilst injecting 0% and 100% of desired signal range, as described on pages 8-11.

4.1 JUMPER FUNCTIONS AND POSITIONS

You will not normally need to set any jumper positions on this model, as they are normally factory set and will not alter any user-variable parameters. They should be positioned as shown below, should their positions be accidentally altered.

S1 jumpers



S2 Jumper



TP1 - This is a test point, and no jumpers should be fitted

4.4

Contact closure programming in

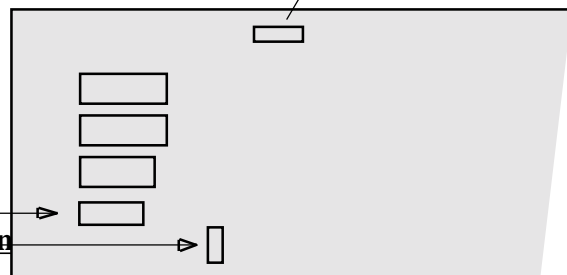

SIGNAL, DATA AND CONTACT CLOSURE CONNECTIONS

4.2 Analogue Input Connections

The large display can accept mA process input signals directly from an active source, can excite passive 2 wire transmitters, or can accept voltage inputs. **Do not** ground the shield of the input cable, but **do** connect it to the shield of your extension cable, which should also **not** be grounded. Typical examples are shown below ...

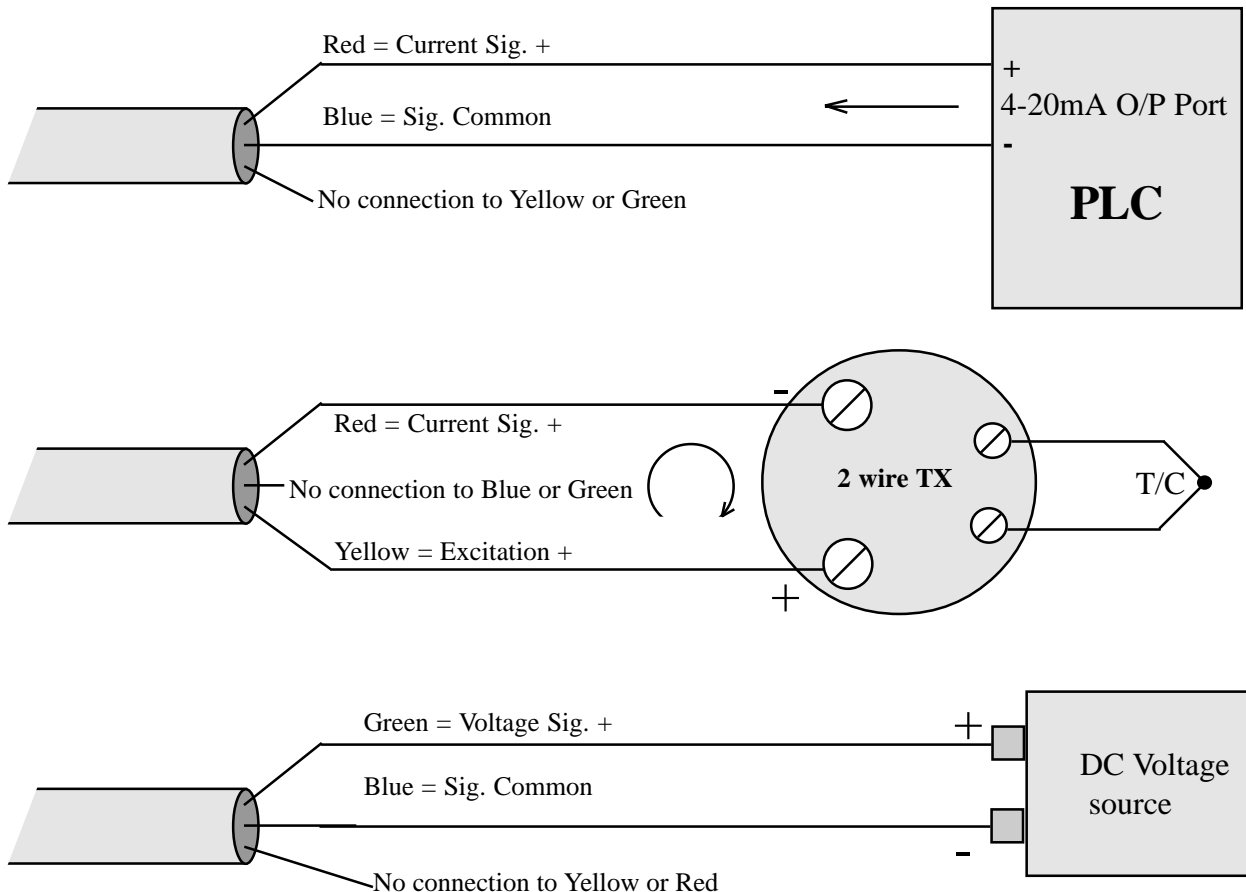

4.3 RS485 Data Output:

The Serial Data O/P cable allows you to feed the measured reading to serial input slave displays, such as our S17XX series, or small 1/8 DIN INTUITIVE-S models, for remote indication purposes.

The output is continuous, with a new string transmitted at roughly 1 second intervals. The format is the reading itself, including decimal point character, in ASCII, terminated by a Carriage Return. The data format is 1 start bit, 8 data bits and 1 stop bit.

The Baud rate is selectable, and is determined by the fourth character of the Configuration Number.

Extension cable should be screened, high quality data cable, and should be routed away from sources of electrical noise such as motors, power cables, inductive devices, discharge lighting circuits etc. **Do not** earth the screen of the data cable, however, as it is already connected to internal earth on the display itself.

Up to 32 slaves having RS485 inputs can be driven from the output port.

Function **Supplied wire colour**

Increment Blue

Select Green

Menu Yellow

Common Red

4.5

PROGRAMMING YOUR DISPLAY

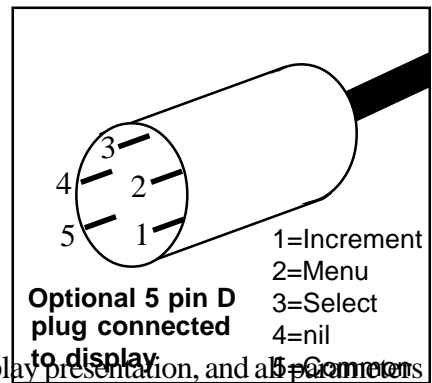
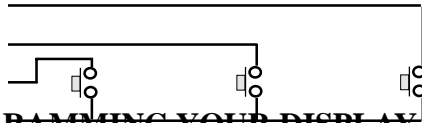

The Process Large Display offers useful flexibility in scaling and display presentation, and all parameters are adjusted by using the three contact closure programming pushbuttons.

It is worth spending a little time familiarizing yourself with the menu and the programming technique before carrying out a full calibration. The menu structure is described below, and is followed by a flow diagram to add clarity.

The flow diagram uses pictures of our Remote Programmer, consisting of three pushbuttons, arranged as follows....

If you make up your own programmer, please be sure to use good quality pushswitches, and lay them out in the same order as shown here.

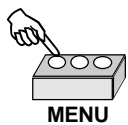
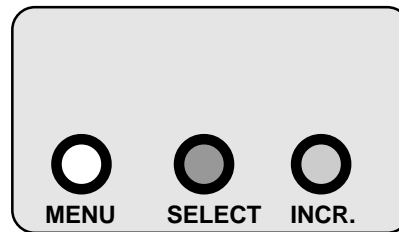

Allows you to enter the programming menu, and steps down all the variable options



Allows you to select a digit within a variable, for alteration. The digit which can be altered flashes. Each time you press 'SELECT' the flashing digit moves one place to the right. Also toggles between NETT and GROSS when in display mode



Allows you to increase the value of any flashing digit. Each press will increase the value by 1. Also TARES or ZERO's the display when in display mode.

The Programming Menu

As you enter the menu, prompts will appear on the display. Because they are formed with simple 7 segment displays, they do not appear to be familiar letter shapes, but are described in detail here.

R SPn This is the reading span. It is the difference between full scale and zero scale display values relating to 0% and 100% of applied input signal.

For example, if you wish to calibrate your display so that 0-100% input gives a reading of -40.0 to +75.0, your Reading Span is 115.0. You can set the decimal point when in the R Spn setup section by pressing SELECT 5 times until the whole display flashes, then pressing INCREMENT to place the decimal point in the desired position.

R ZEr This is the display value you wish to have with 0% of input signal. So, for the example given above, R Zer would be -40.0

IP Lo and **IP HI** are the 0% and 100% input signals respectively, typically 4 and 20mA, 0 and 10V, etc. In fact, you do not even need to know the actual 0% and 100% signal levels. The display measures applied 0% and 100% signals, rather than requiring you to tell it the values. So, if calibrating a weighing platform, IP LO means no load on platform, IP HI means known deadweight placed on platform equal to R Spn. The known deadweight should be as near to full scale capacity as possible to ensure optimum accuracy of calibration, though not essential.

If recalibrating the input stage, you would apply 0% signal, say 4ma, at the 'SURE' prompt after IP LO, then save this data by pressing INCREMENT, keeping it pressed, then pressing SELECT also. The display will briefly say IP HI, followed again by 'SURE?'

Now apply 20mA and press INCREMENT, keeping it pressed, and press SELECT.

You do not need to carry out this procedure if the display has previously been set for the desired input range. For example, if your display is calibrated 4-20mA for a display range of 0-100.0, and you wish to recalibrate to have 4-20mA giving 0-60.00, you would simply change R Spn to 60.00, from 100.0. When you come to IP Lo and IP HI in the menu, at the prompt 'SURE?', simply press MENU, and you will retain the original 4-20mA input calibration.

CnFlg is the Configuration number. This determines the display presentation, filtering effect, and brightness setting.

Use the space below to work out your required settings and record them for later use if necessary.

Display Serial Number	=	<input type="text"/>
Approximate 0% Signal	=	<input type="text"/>
Approximate 100% Signal	=	<input type="text"/>
R Spn (Reading Span)	=	<input type="text"/>
R Zer (Reading Zero)	=	<input type="text"/>
Cnfig (Configuration number)	=	<input type="text"/>

Menu Flow Diagram

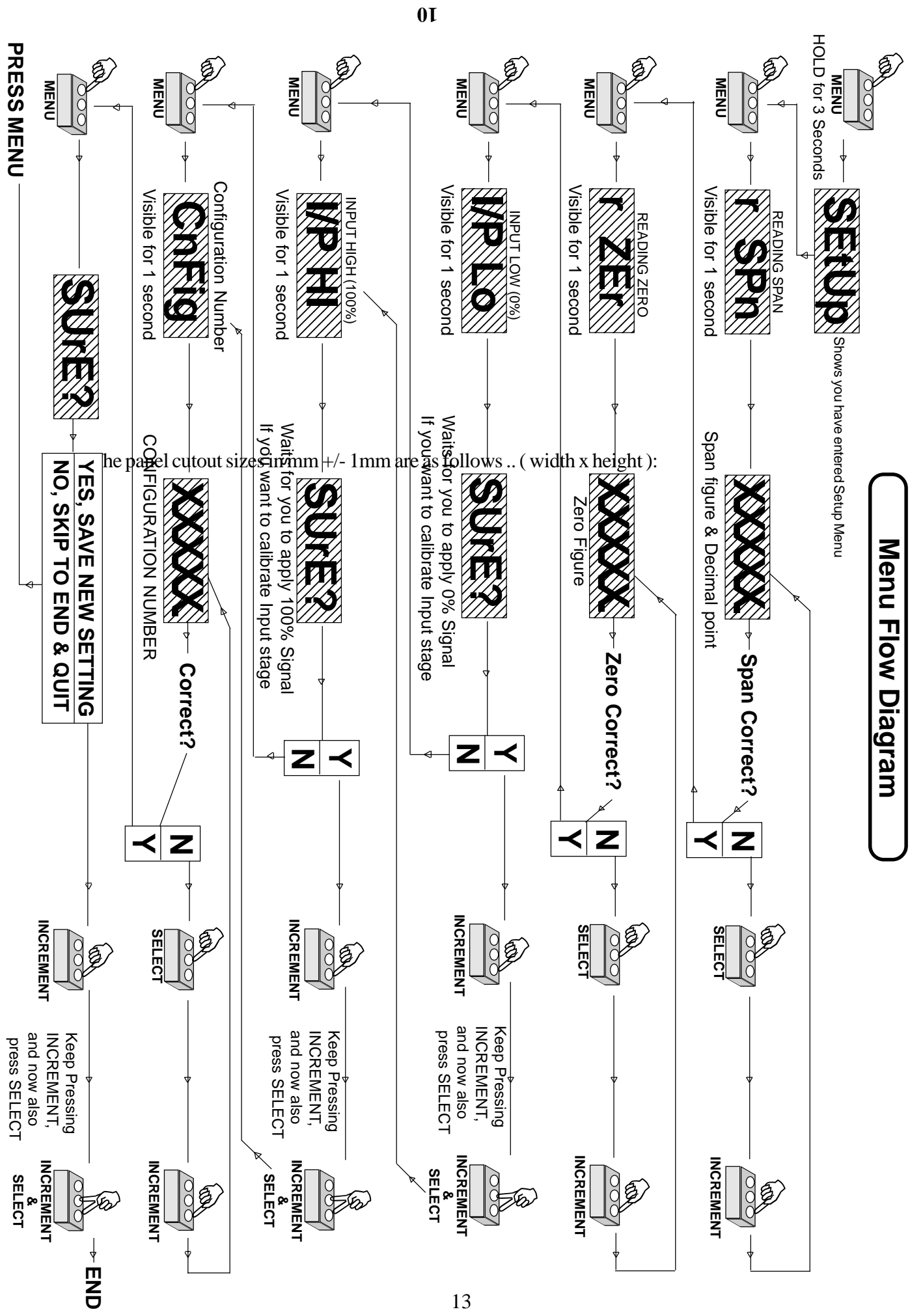

the panel cutout sizes in mm +/- 1mm are as follows .. (width x height):

4.8 THE CONFIGURATION NUMBER & WHAT IT DOES

The configuration number consists of 5 digits and appears briefly after initial power-up, immediately after the digit test sequence when all 8's are displayed.

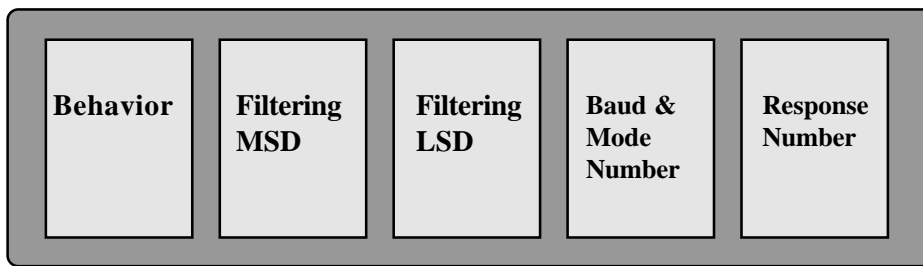

The significance of each of these digits is described below.....(Default = 40054)

4.9 1st CONFIG. DIGIT-BEHAVIOR

The first digit in the Setup number affects the way the measurement is displayed on the indicator, and can be used to centralise digits if only 3 digits of resolution is required, round up the reading, blank leading zeros etc.

Least Significant digit roundup	1	2	5	10	20	50	100
	↓	↓	↓	↓	↓	↓	↓
No leading zero blanking	0	1	2	3	n.a.	n.a.	n.a.
Leading zero blanking	4	5	6	7	D	E	F
Right hand digit blanking	8	9	A	B	n.a.	n.a.	n.a.

Default = 4

n.a. = Not Available

4.10 2nd & 3rd CONFIG. DIGITS-Filtering

These digits determine the degree of filtering , and as a result the speed of response of the display. Settable range presently limited to 00 to 07 . Select to suit max. period of oscillation of input signal.

00 = no filtering	01=0.5 Sec sample	02=1.0 Sec sample
03 = 2.0 Sec sample	04=4.0 Sec sample	05=8.0 Sec sample
06= 16.0 Sec sample	07=32.0 Sec sample	

4.11 4th CONFIG. DIGIT-BAUD RATE SELECTION DIGIT

For the Process Input display, this digit of the configuration number is used to set the baud rate of the RS485 transmission output.

Baud Rate digit	4	5	6	7	Default = 5 (1200 Baud)
Baud Rate	300	1200	2400	9600	

4.12 **5th CONFIG. DIGIT-RESPONSE NUMBER**

This character has no relevance on the process meter, as it is concerned solely with serial data input responses. It is set to default as **4**

4.13 **6th 'INVISIBLE' SETUP DIGIT-BRIGHTNESS**

The brightness of the display can be altered using remote pushbutton programming. Once in the Configuration sequence, use 'Select' to make the right-hand digit flash. Press 'Select' once more, and the whole Configuration number will start flashing. Now, each time you press 'Increment', you will notice that the display's brightness will change. There are 4 choices of display brightness. When a suitable brightness has been found, you may store it by pressing 'Menu', at which point the display will show the prompt "SURE?". Press and hold in the INCREMENT button, and, without releasing it, then also press the SELECT button.

5.0 **INSTALLATION**

If possible position the display away from heat and direct sunlight on the display face. The displays should not be exposed to substances liable to damage uPVC, acrylic or glass.

If mounted outside, the display should be protected by a shroud to limit direct falls of rain, the cooling effect of which can give rise to the display sucking in moisture.

DO NOT remove the cables supplied with the indicator, as these contain essential filter components. You should extend cables with a junction box rather than remove and substitute cabling. Screening must be used on your cables.

REMEMBER The signals you will be feeding to the displays are quite small in comparison to some of the undesirable 'noise' generated by certain types of common electrical equipment. To obtain the highest degree of accuracy and reliability from your indication equipment, we strongly suggest that you....

DO use shielded, twisted-pair cable to minimise the amount of noise being fed into the display.

DO NOT run signal cables adjacent to power/switching lines or near equipment liable to generate large amounts of electrical noise, such as contactors, solenoids, fluorescent tubes, discharge lamps, motor control equipment, etc. **DO NOT** ground the shields of signal, data or programmer cables.

5.1 MOUNTING POSITIONS

Digit Height	Cutout size
57mm	279x111
102mm	471x159
144mm	615x183
200mm	815x239
280mm	1163x327

Method :

Remove fixing screws and slacken the cable glands. Ease rear case off front section, leaving rubber gasket on front section. Offer front section up to panel cutout. Feed cables through glands in case rear. Slide rear over front section, pulling any excess cable through glands. Fit all screws and washers, and finger tighten glands.

5.3 WALL MOUNTING

Fixing centres (mm, horizontal) Hole pitch 100mm vertical

Digit height	Fixing centres
57mm	288
102mm	480
144mm	624
200mm	824
280mm	1172

Method : Fix the wall mounting brackets to the wall with rawlplugs and screws or nuts and bolts.

Offer the case up to the brackets and insert the screws and washers supplied at each end of the case. Note the position of the friction washers. Tighten the mounting screws sufficiently to hold the display in position. Do not over-tighten.

5.4 SUSPENSION MOUNTING

Method :

Connect the U shaped bracket with the supplied screws and washers to each end of the display. Tighten the screws sufficiently to hold the display in place. Do not over-tighten.

Drill an 8.5mm diameter hole in the beam where the display is to be fitted. Slide the supplied bolt through the bush. Feed this through the center hole of the suspension bracket and place the bearing washer on top. Push the bolt through the drilled hole and secure with the nut and washers supplied. Please note that the drilled hole should be sufficiently clear from any obstruction to allow the display to swing 360 degrees and pivot up and down.

5.5 MULTIPLE DISPLAY MOUNTING

Refer to the information supplied with the mounting kit.

6.0 TROUBLE SHOOTING AND MAINTENANCE

The Large displays have been designed to provide a long trouble-free life and require no routine maintenance. An annual calibration check is recommended.

The front lens may be cleaned with a proprietary window cleaner, and the case may be hosed down, and cleaned with a cloth dampened with mild detergent. Surface scratching can be polished out with a mildly abrasive cleaner such as perspex cleaner.

The power supply is for 95 to 264 volts AC, so there is no risk of applying 240 volts to a 110 volt unit. Filtering is incorporated on the power input, to prevent damage due to short spikes on the supply

Check wiring prior to powering the units!

ERROR MESSAGES

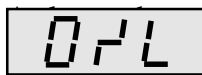

Means 'Overload'. Your I/P signal is more than 22mA or 11 VDC. Check input cabling connections, and input source. If current I/P, measure resistance between blue and red input wires, which should be approx. 45 Ohms. If greater, either the input jumper has not been fitted, or an excessive current has been fed to the unit, blowing the input shunt resistor. Check wiring.



Means 'OverRange'. Your scaling has meant that the display value is exceeding 99999. Check scaling and Input level to ensure they are within the permissible limits of the display.

7.0 SAFETY CONSIDERATIONS

This product is protected in accordance with IEC Safety Class 1. The instruments are designed and tested in accordance with IEC publication 348, 'Safety Requirements for Electronic measuring apparatus', and are supplied in a safe condition.

Whenever protection is likely to have been impaired by damage, the equipment shall be made inoperative and be secured against any intended operation.

Removal of the rear cover **WILL EXPOSE LIVE PARTS**. The equipment must be disconnected from the supply before carrying out any adjustments, replacement, or repair with the case opened.

If any work is carried out with the equipment opened and powered, it shall only be carried out by a skilled person who is aware of the hazard involved.

Power connections:

The unit is operable as soon as the mains is applied, there is no mains switch.

The equipment must be connected to a protective earth. Any interruption of the ground conductor inside or outside the equipment is likely to make the equipment dangerous.

The power and signal leads should not be allowed to collect within the instrument; all excess lead must be pulled out through the cable glands.

Note that capacitors inside the instrument may still be charged when the equipment has been disconnected from the supply. Before carrying out any work inside the equipment, a period of one minute should be allowed for capacitors to discharge; to discharge the mains filter capacitors, short together the live and neutral mains wires.

R F I

The equipment generates and uses radio frequency energy, but when properly installed as described, complies with EN55022. The equipment is certified as meeting EN50081-1 and EN50082-1

Shielded cables **MUST** be used for all signal and data leads, but use of a shielded power lead is not required. The power ground wire must be bonded to a good ground, but **DO NOT** ground the signal, data or remote programmer shields.

8.0 WARRANTY

We warrant our products against defects in materials or workmanship for a period of one year from the date of purchase.

In the event of a defect during the warranty period, the unit should be returned, freight(and all duties and taxes) prepaid by the Buyer to MAGTROL. We will, at our option, repair or replace the defective unit. The unit will be returned to the Buyer with freight charges prepaid by the MAGTROL.

LIMITATION OF WARRANTY

The foregoing warranty shall not apply to defects resulting from:

1. Improper or inadequate maintenance by the buyer.
2. Unauthorised modification or misuse.
3. Operation outside the environmental specification of the product.
4. Mishandling or abuse.

The warranty set forth above is exclusive and no other warranty, whether written or oral is expressed or implied. We specifically disclaim the implied warranties of merchantability and fitness for a particular purpose.

EXCLUSIVE REMEDIES

The remedies provided herein are the buyer's sole and exclusive remedies. In no event shall MAGTROL be liable for direct, indirect, incidental or consequential damages (including loss of profits) whether based on contract, tort or any other legal theory.

9.0 DIMENSIONS

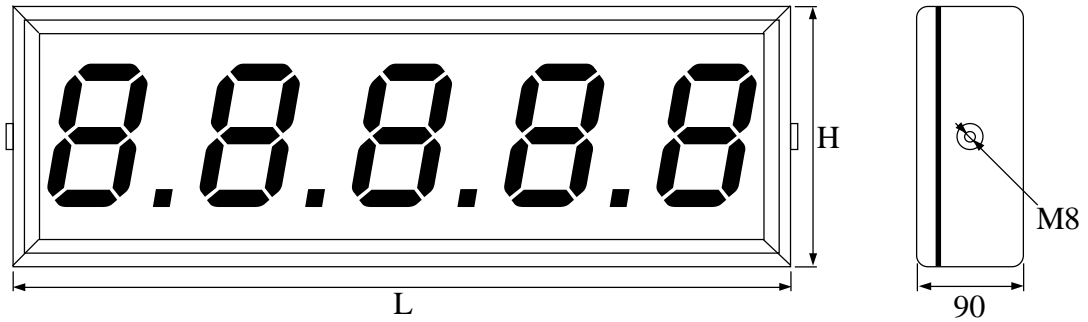

Size	L	H	Weight kg
57	288	120	2.5
102	480	168	4.5
144	624	192	5.5
200	824	248	7.0
280	1172	336	12.0

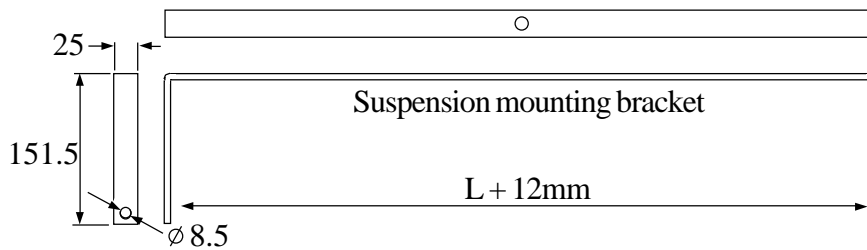
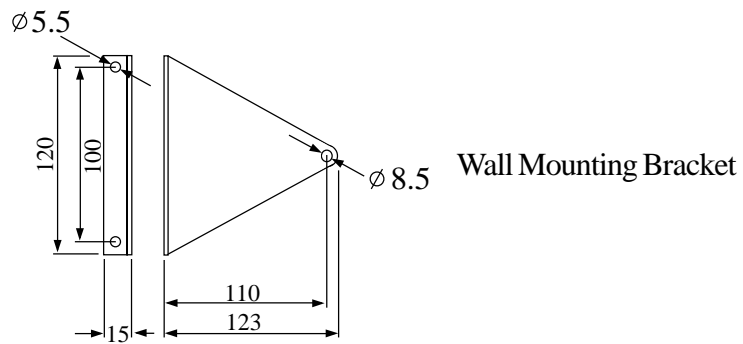

Notes